

Installation and maintenance manual
***Outdoor indirect gas
heater AGX 55 / 85***

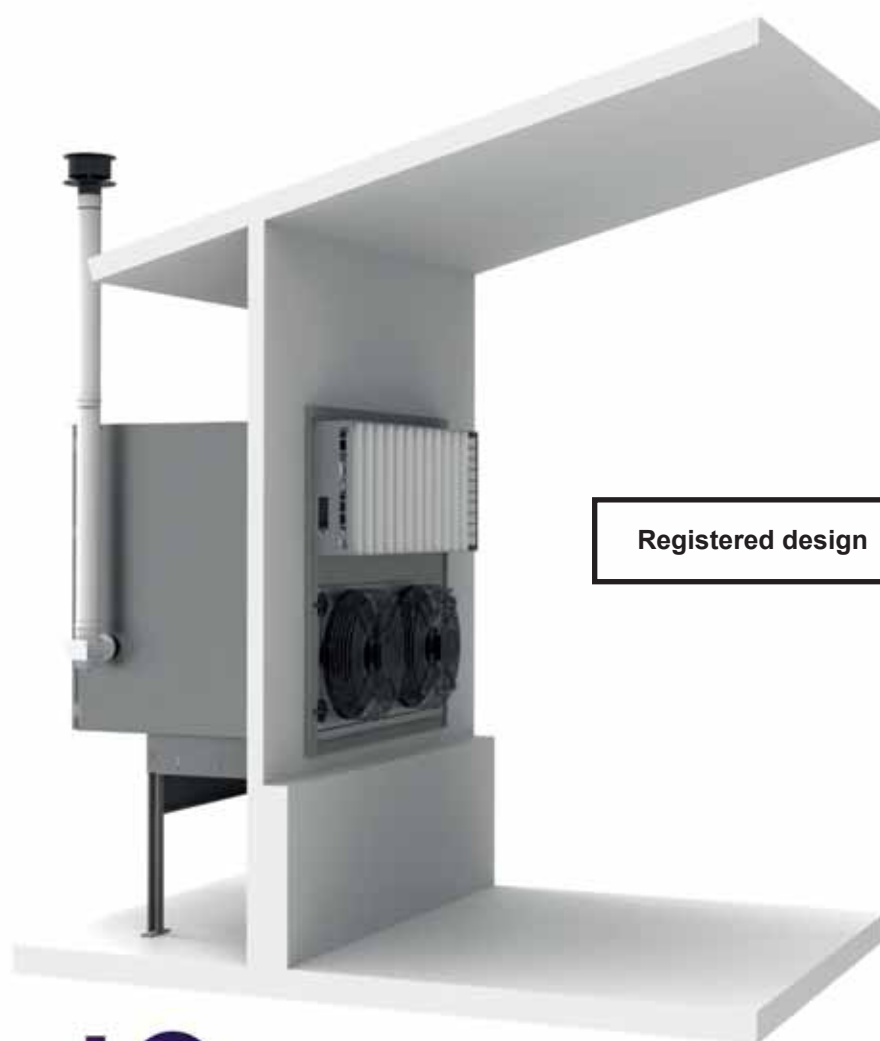

Registered design

4heat^o
heating & ventilation

4heat s.r.o. | Ječná 1321/29a, 621 00, Brno, Česká republika
+420 513 035 275 | info@4heat.cz | www.4heat.cz

DTC20-150 EN

TABLE OF CONTENTS

Section No.	Section	Pages
1	GENERAL INFORMATION 1-1 General recommendations 1-2 Unit description 1-3 Instruction for use 1-4 Operating 1-5 Safety	5 - 6
2	TECHNICAL SPECIFICATIONS 2-1 Performance of gas heater AGX 2-2 Dimensions	7
3	INSTALLATION 3-1 Recommendations for the installation 3-2 Assembly	8 - 9
4	ELECTRICAL CONNECTION 4-1 Electrical diagram 4-2 Electrical connection 4-3 MODBUS wiring with REG422 and REG423 interface 4-4 Wiring in 0/10Volts or ON/OFF	10 - 15
5	FLUE PIPE CONNECTION 5-1 Generalities 5-2 Flue pipe connection	16
6	GAS CIRCUIT 6-1 Generalities 6-2 Connection	17
7	COMMISSIONING 7-1 Commissioning 7-2 Operating mode 7-2a Messages and functions 7-2b Language settings 7-2c Auto and Manual modes settings 7-2d Temperature settings in manual mode 7-2e Temperature settings to start blowing 7-2f Device address settings 7-3 Bills of material	18 - 27
8	CHANGE OF GAS	28
9	MAINTENANCE	29
10	TROUBLESHOOTING 10-1 Diagnostics and defaults 10-2 Faults display 10-2a AIR PRESSURE SWITCH FAULT 10-2b BLOWING SENSOR FAULT 10-2c BURNER AND CONTROL BOX FAULT 10-2d OVERHEAT FAULT 10-2e AMBIENT SENSOR FAULT 10-2f COMMUNICATION FAULT 10-3 Air pressure switch replacement 10-4 Electronic PCB replacement 10-5 QUALIFIED TECHNICIAN SETTING 10-5a Switch differential setting 10-5b Temperature differential setting 10-5c Ventilation temporization setting 10-5d Temporization settings of switching from low speed to high speed 10-5e Temporization settings of burner off after high speed 10-5f Communication speed setting 10-5g Information, non configurable	30 - 37
11	RECOMMENDATION FOR USERS	38

AVERTISSEMENT

CE marking

This equipment complies with the essential requirements of Regulation (UE) 2016/426 « Gas devices ». It is registered on the 12th of September 2019, standards EN1020:2010.

The devices in this manual comply also with following directives:

- It is in conformity with the European directives 2009/142/CE applicable to gas devices
- It is in conformity with the regulation (UE) 2016/426 applicable to gas devices

Concerning the technical demands that are required, the CE marking is the official recognition of the quality of design, manufacture and performance of this device. Its long lifetime and its performance will be at optimum level if its use and its maintenance are properly carried out and the regulations in force.

Responsibility

This equipment must be used expressly for the purpose for which **4heat** has designed and manufactured it. Any contractual liability of **4heat** is therefore excluded in case of damage undergone by persons, animals or goods, following errors in installation, settings, maintenance and inappropriate use.

The devices must be equipped exclusively with genuine accessories. **4heat** will not be held responsible for any damage whatsoever arising from the use of an accessory which is inappropriate to the device.

The devices must be installed by qualified professional workers, respecting the regulations and decrees in force, and in accordance with the instructions shown in this instruction manual. The installer is required to establish installation conformity certificates produced by the ministries responsible for the construction and safety of gas. References to standards, rules and directives mentioned in this manual are given for information purposes and are only valid at the date of printing this manual.

4heat is responsible for the conformity of the device to the rules, directives and standards of construction in force at the time of marketing. Knowledge and respect for the legal provisions as well as the standards inherent in the design, implantation, installation, commissioning

Reception – Storage

The gas unit heater is delivered on a wooden pallet, protected by cardboard packing and a plastic film. It is essential to check the condition of the equipment delivered (even if the packing is intact) and its conformity compared to the order.

In case of damage or missing parts, you must report the observations on the transport company's receipt form in the most precise way possible, "subject to unpacking" has no legal value, and then you must confirm those reservations by registered letter within 48h to the transport company. We remind you that it is the responsibility of the buyer to check the delivered merchandise, no recourse will be possible if this procedure is not respected.

Store the equipment in a clean and dry room, away from shocks, vibration, divergences in temperature and in an ambient environment with a rate of hygrometry lower than 90%.

Guarantee

Your device benefits from a contractual guarantee against any manufacturing defect, the duration of that guarantee is shown in our catalogue.

Our liability as a manufacturer cannot be committed when incorrect use of a device has occurred, where there is a defect or of an insufficiency in the maintenance of that device, or an incorrect installation of the device (it is your responsibility, as regards this, to check that the latter is carried out by qualified professionals).

In particular we will not be held responsible for material damage, intangible losses or bodily injury resulting from an installation which does not conform:

- to the legal and regulatory provisions or those imposed by local authorities,
- to the national or local or particular provisions governing the installation,
- to our instructions and recommendations for installation, in particular the regular maintenance of the devices,
- to the rules of the trade.

Our guarantee is limited to the exchange or repair of only those parts which are recognised as being defective by our technical departments, excluding the cost of labour, travel and transport.

Our guarantee does not cover the replacement or repair of parts as a result of, in particular, normal wear, incorrect utilisation, service visits by unqualified third parties, a defect in or insufficiency of maintenance or surveillance, non-conforming electrical supply and the use of a fuel which is inappropriate or of bad quality.

Sub-assemblies, such as motors, pumps, electric valves, etc..., are only guaranteed if they have never been removed.

The rights established under the European directive 99/44/CEE, transferred by the legislative decree No. 24 of 2 February 2002 published on the Official Journal No. 57 of 8 March 2002, remain valid.

PLEASE READ CAREFULLY BEFORE CONTINUING



This technical manual must be kept in good condition inside the unit.



THIS PRODUCT IS EXCLUSIVELY RESERVED FOR A PROFESSIONAL USE. ONLY QUALIFIED PERSONS ARE ALLOWED TO HANDLE IT. IT CANT BE ACCESSIBLE
IL NE DOIT PAS ÊTRE ACCESSIBL TO THE PUBLIC.



The specifications, illustrations and description contained in this manual are, to our knowledge, accurate at the time of the approval to print. We reserve the right to stop offering some characteristics or to stop the production of a model without notice it, do not constitute an firm agreement of our share.

Safety rules



- It is forbidden to plug and/or reduce the aeration openings of the installation room or the device,
- Never obstruct the smoke evacuation or the new air intake,
- Never make any modifications to the settings made by qualified personnel,
- Never spray water on the unit heater, or touch the device with parts of the body which are wet and/or with naked feet,
- Never touch hot parts of the unit heater, and/or moving parts,
- Never put or hook any object onto the device,
- Any operation on the device is forbidden unless it has been disconnected from the electricity network and the gas supply has been cut off.
- Do not modify the type of gas used, the settings of the device, the safety systems and regulation systems, since that could create dangerous situations.

Warn the after-sales technician in the case of changing the gas, the gas pressure or modifying the supply voltage.

In the case of a long period of non-operation, disconnect the electrical supply from the device. When starting the operation again, you are advised to call on qualified personnel. As a general rule all repair and/or maintenance visits must be carried out exclusively by authorised and qualified personnel.

The taking out of a maintenance contract is strongly recommended “see this with your installer”.

Cautionary note



Electrical components, drive mechanism and combustible gas can cause injuries. To protect from those risks during the installation or the maintenance, the power supply must be cut and the gas valve closed. Any person involve in the installation or maintenance of this equipment must respect the health and safety standards.

What should you do if you detect a gas smell :



- Close the outside gas valve and the electrical supply then, inform a technician for maintenance.
- Do not try to switch on the device
- Do not switch on the power supply, do not use phone inside the building.
- Call your gas supplier from another phone. Follow the instructions given by your supplier.
- If you cannot contact them, call the fire department.

1-GENERAL INFORMATION

1-1 General recommendations

The gas heater **AGX** range are intended for the heating of industrial premises and poultry houses, for indoor use only.

The unit can only be installed in rooms which are sufficiently ventilated, except if it has a sealed connection.

The proper functioning of the gas heater depends on correct installation and commissioning. Installation and maintenance must be carried out by qualified personnel in conformity with the regulatory texts and the rules in force.

The non-compliance with such rules entails the rejection of all responsibility from the manufacturer.

DO NOT INSTALL GAS HEATERS IN :

- Rooms which have a risk of explosion,
- Rooms containing chlorinated combination steam,
- Rooms with a high content of combustible dust,
- Rooms which are excessively humid (electrical danger),
- Corrosive environment
- Domestic premises

After having checked that the installation respects the recommendations of this notice, it is the responsibility of the installer:

1) to inform the user:

- that it cannot carry out itself any modifications to the design of the devices or the method of carrying out the installation; the least modification (exchange, withdrawal....) of safety components or parts which influence the efficiency of the device or the hygiene of combustion will systematically cause the withdrawal of the EC marking.

- that it is necessary to recommend cleaning and maintenance operations.

An annual preventive maintenance operation is compulsory.

2) to give these instructions to the user. They form an integral part of the device and must be retained and must accompany the device, even in the case of sale to another owner or user.

Being always intent on improving the quality of our products, we seek to improve them on a permanent basis. We therefore reserve the right, at any moment, to modify the specifications shown in this document.

1-2 Description of equipment

The gas heater **AGX** is an independent hot air generator, running on natural gas and on propane.

It constitutes a "direct" heating gas system ; it is a device for the production and the emission of heat without an intermediate vehicular fluid. For the whole range described in these instructions, the combustion products are evacuated out of the room by an extractor. The combustible air is taken from the ambient environment or from outside. Those units can be connected with single flue kit, B22 type.

The gas heaters of the **AGX** range work with different gas indicated on the identification plate in conformity with the European directive.

1-3 Instruction for use

- Please read the instructions in this manual carefully for the operation and maintenance of this device.
- Carry out maintenance at least once a year by qualified personnel. The frequency of the maintenance operations depends on the environment in which the device is installed. More regular inspection must be carried out in dusty locations.
- **If the unit is used in poultry houses**, it must be cleaned after each lot of animals, or more if there is a high degree of pollution.
- Regularly check that device, the chimney or the gas pipe are not damaged.
- Regularly check that air openings in the building and around the device are not obstructed.
- Check that hot air circulates normally in the room, and therefore that there is no obstacle on the suction side (fan side), and in front of the blowing side of the unit (check that the grille is well opened).
- The control box must have a cut off electricity each 24 hours.
- For the devices working with LPG, please note that it is not recommended to go down below 1/4 of the tank level. Certain additives used in LPG can accumulate and stagnate at the bottom of the tank and cause a premature fouling due to bad combustion. In case of consecutive failure due to a lack of gas, it is mandatory to check the cleanliness of the combustion circuit and to realize a combustion control at the commissioning.

1-4 Operation

When heat is required, the burner ignites using the ignition electrode then the fan starts running, hot air is blown into the room. When the setting temperature is reached, the burner is turned off. The fan continues to turn for about one minute, until it has cooled the heat exchanger.

1-5 Safety

- The ionization sensor detects if there is a flame or not. If not, the gas valves are immediately closed.
- The thermal protection of the heat exchanger is ensured by two thermostats. The first, which is automatically reset, protects against insufficient air flow (obstructions, fan failure). The second, which has to be manually reset, is set to a higher threshold than the first one. It protects the device against overheating due to a functioning problem or unsuitable use.

If the operation shows any difficulty whatsoever, please contact your installer or the After Sale Service of your dealer.

Make sure that the device can be normally supplied with combustion air at atmospheric pressure (it must be taking into account if there is any modification of the building after the installation of the device). An excessive vacuum inside the room can harm the proper functioning of the device and deprive it of air necessary combustion.

2- Technical characteristics



AGX Model

The **AGX** heaters are equipped with an axial fan for a direct blowing into the room.

It is designed to be installed outside or inside a room to heat.

It is equipped in series with 2-stages solenoid gas valve to meet as much as possible the heating needs.

2-1 Performances

TYPES		AGX55	AGX85
Gas Input	kW	51,7	84,7
Nominal Output (Prated,h)	kW	48,1	78,5
Efficiency at Nominal heat output (η_{nom})	%	92,9	92,7
Minimal power (Pmin)	kW	33,9	55,0
Efficiency at minimal power (η_{pl})	%	94	93,8
Fan	Ø [mm]	1x Ø450	2x Ø450
Speed rotation	RPM	1350	1350
Air flow at 15 °C	m3/h	4 800	9 000
Gas flow at 15°C - Natural G20	20 mbar	5.3 m3/h	8.5 m3/h
- Groningen G25	25 mbar	5.9 m3/h	9.5 m3/h
- Propane G31	37 mbar	3.9 kg/h	6.3 kg/h
Smoke exhaust diameter	Ø [mm]	80	80
Supply voltage	Monophasée 230 Volts / 50 Hz - IP54		
Electrical power	W	670	990
Electrical current	A	3	4,5
Electrical Consumption (Blowing fan excluded)			
At Nominal heat output (elmax)	kW	0,14	0,14
At Minimal power (elmin)	kW	0,1	0,1
Emissions of nitrogen oxides (Nox)	mg/kWh	< 99	< 99
Seasonal energy efficiency for space heating ($\eta_{s,h}$)	%	74,79	75,46
Operating temperature	°C	0/+40°C	
Weight	kg	200	280

2-2 Dimensions

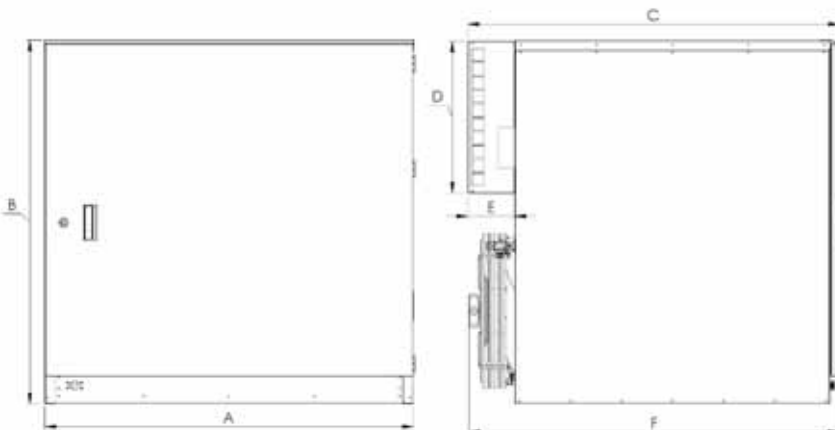

Types	AGX55	AGX85
A (mm)	740	1120
B (mm)	1110	1110
C (mm)	1130	1130
D (mm)	462	462
E (mm)	145	145
F (mm)	1125	1125
Fumes (mm)	Ø 80	Ø 80
Gas (mm)	3/4" M	3/4" M

3- INSTALLATION

3-1 Recommendations for the installation

For a good functioning and the security of the device, it is imperative to respect some installation rules :

- Make sure the stand is strong enough.
 - Keep enough distance between the device and any obstructions.
 - Do not obstruct the access doors to the technical compartments, take into account the possibility of opening the access for maintaining and cleaning operations.
 - Be careful to every flammable products. Ensure you that the air flow to and from the heating device is without obstruction, and the warm air can freely flow.
 - No object can be placed at less than 5 m around the heater.
 - The device is delivered with M8 fixation points, check the technical drawings.
 - Make sure that, after assembly, there is no mechanic tension on the gas or electric connection.
 - Make sure that the flues pipes are enough cleared for correct operation, see chapter concerned.
- Install the device perfectly horizontally.

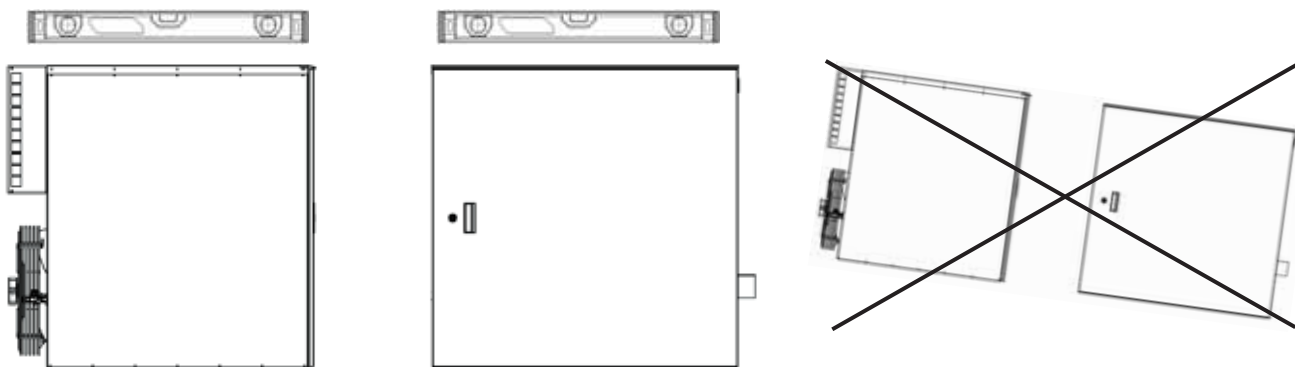

Dimensions for installation:

It is possible to pass the cables or linkage of ventilation windows, in front of the device:

- Behind the diffuser, through an adapted hole (125x50)
- Between the diffuser and the fans.

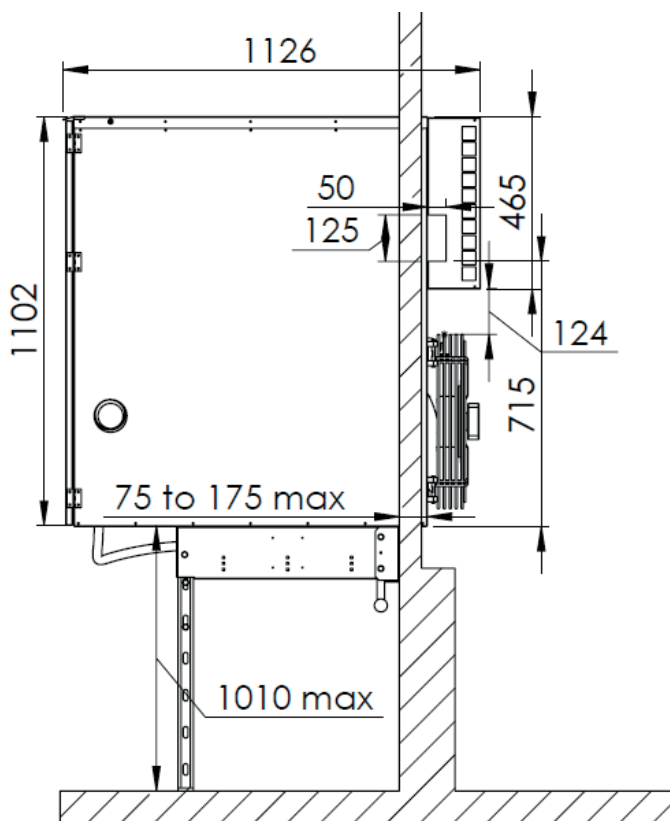

3-2 Assembly

- Make an opening in the wall but keep a minimum space to slide the device in this opening. Be careful to respect the clearance dimensions.
 - Put the sheet steel base of the support on the wall and fix the 2 sheet steel on the both sides of the sheet steel base.
 - Mount the support feet and adjust the height (refer to the installation manual). Make sure that the support feet are placed in a permanent hard surface, be careful with soft soil (mud, sand, etc.)
 - Fix the sheet steel between the support feet in order to get a rigid set, check the levels of the bracket, the set must be perfectly horizontal.
 - Place the unit on the support and slide it to the correct position by respecting the clearance sides.
- Fix the device on the bracket with two screws placed under the lateral sheet steel.

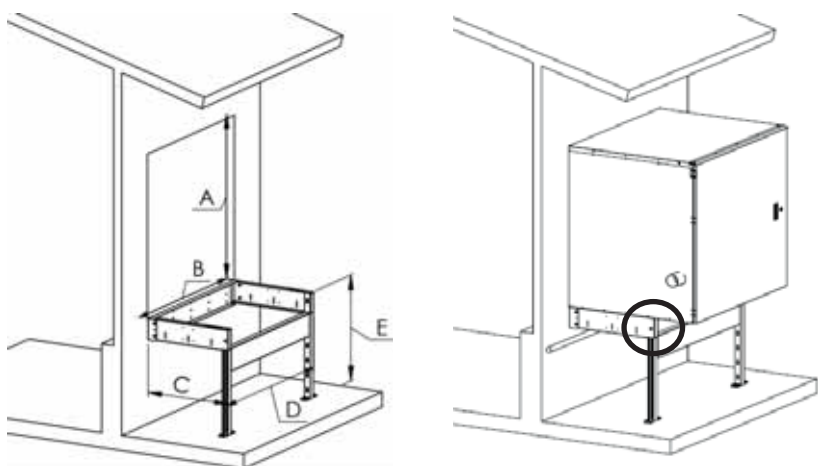

	AGX55	AGX85
A	1120	
B	750	1130
C	600	
D	750	1130
E	1010 max	

Dimensions of installation

Indoor view

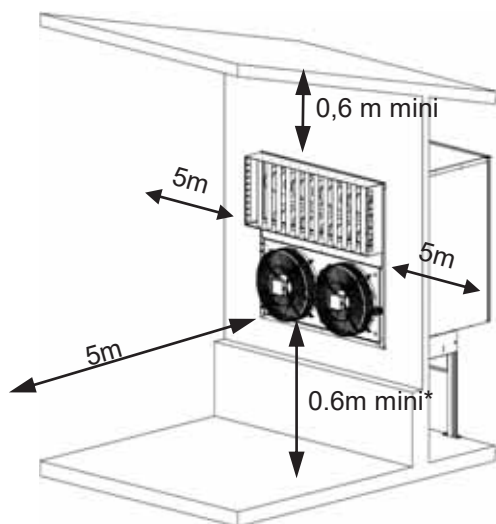

Outdoor view

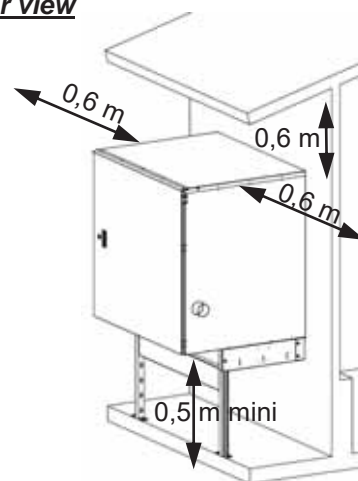

- Cover the perimeter of the device, both inside and outside the wall. Be sure of the sealing of the assembly by applying a sealing paste adapted to the material and weather conditions.

- Caution, if the slope of the roof ends over the device, make sure to place a gutter. The rainwater cannot flows on the device!

(*) This height must be checked depending on the type of husbandry or the configuration of the local.

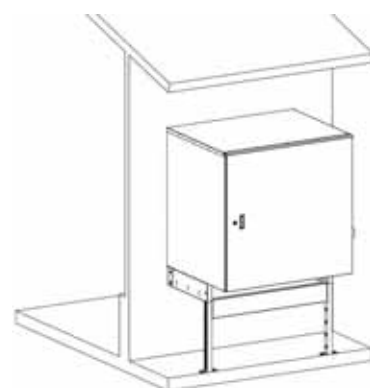

4- ELECTRICAL CONNECTION

Caution, before any action, make sure that the electricity is cut off, to avoid any electrocution risk. These actions must be realised by a qualified person with the required qualifications.

4-1 Electrical diagram

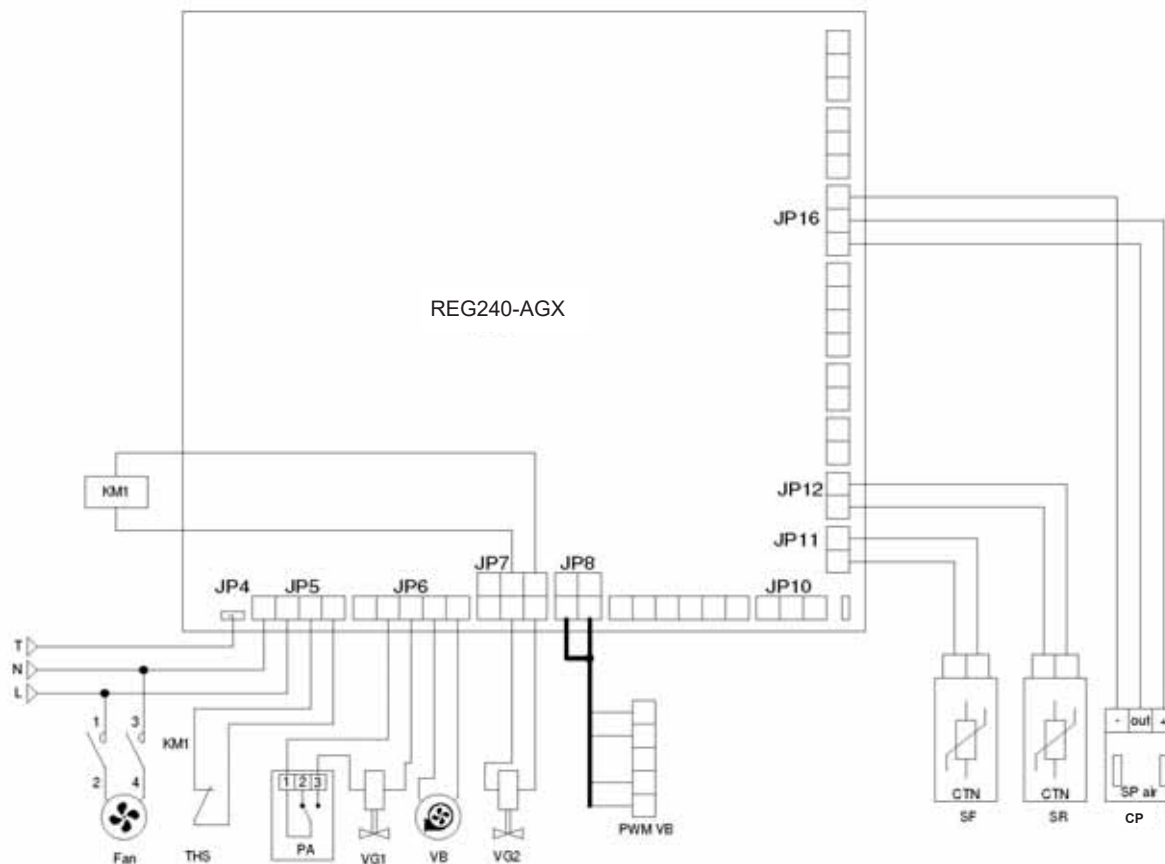

REG240-AGX	Communication and management card
FAN	Blowing fan
THS	Overheating safety thermostat
PA	Differential air pressure switch
VG1 /VG2	2-stages solenoid gas valve

KM1	Fan contactor
VB	Combustion burner fan
SF	Heat exchanger temperature sensor
CP	Differential pressure sensor
PWM	Combustion fan control

4-2 Electrical connection

The installation must satisfy the actual local or national rules.

The power supply of the device is on 230V/50hz single phase, with a protected electric cable. Section and protection of the cable must be dimensioned regarding the device number on the line and its length.

Be sure that you dispose of a proper safety ground connection.

Check if the tension and the voltage of the electricity supply correspond to the necessary requirements.

To ensure people safety and device safety, it is recommended to have electrical isolators proximity (1)

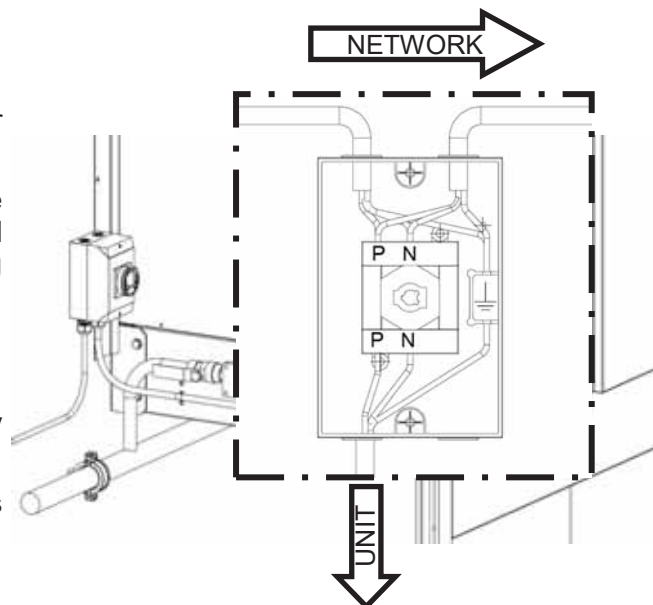

4-3 MODBUS wiring with REG422 and REG423 interface

The REG422 and REG423 are controllers connected to the devices by MODBUS communication. They allow the dialogue between the customer control system and the devices (up to 6 maximum).

These interfaces provide the status of the device. From the screen, it is possible to check the state of each unit, the working time, the gas consumption, and the component's information. The REG423 controller also memorize the historic its device's defaults. The REG422 is a controller with keypad, the REG423 is a touchscreen controller.

Communication between the customer control system and the REG422 or REG423

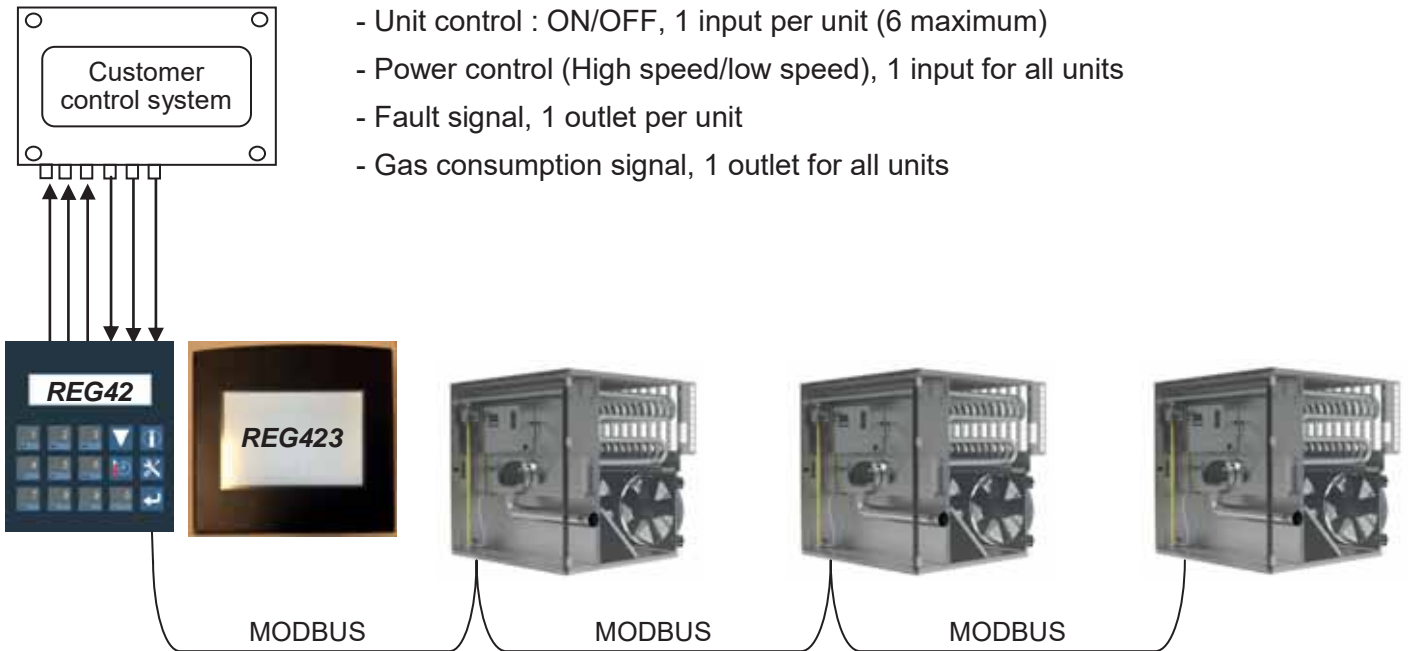

It is mandatory to use a cable UNITRONIC BUS LD 2 x 2 x 0.22 to connect in MODBUS. It is also necessary to connect the braids between them to the ground.

For more details, refer to REG422/423 manual.

Electrical diagram

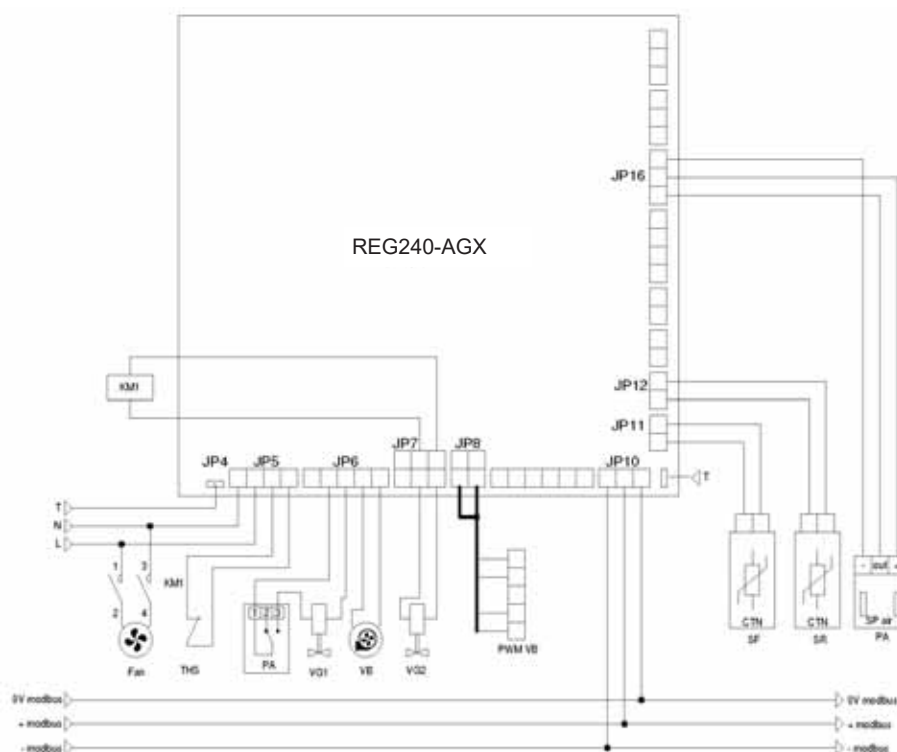

Connection box (in option)



If the option was ordered, the box is inside the electrical compartment of the unit. It allows to connect it to the interface REG422 or REG423.

4-4 Wiring with customer control system in 0/10 Volts or ON/OFF mode :

The communication and management card of the unit allows an 0/10 Volts or an ON/OFF connection directly from the customer control system.

Three modes are available:

- Analog mode: 0/10Volts
- Hybrid (IN 0/10Volts / OUT ON/FF)
- Numeric mode: ON/OFF

The management card is set in factory for MODBUS use. To use the analog or ON/OFF modes, setting must be changed.



The customer connects its system to the management card thanks to a 6 pins screw terminal in JP9.

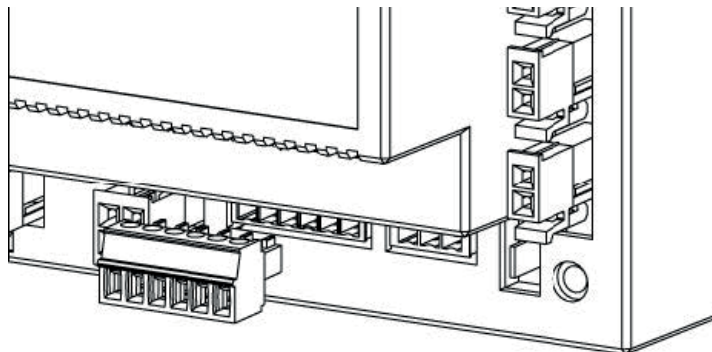

Terminal numbers:

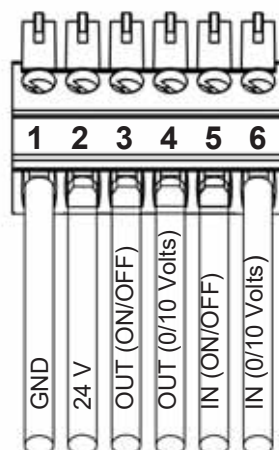

Analog mode connection :

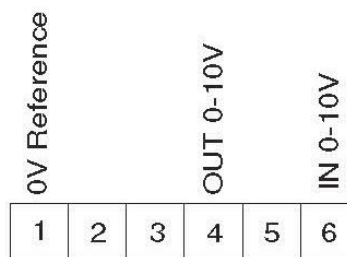
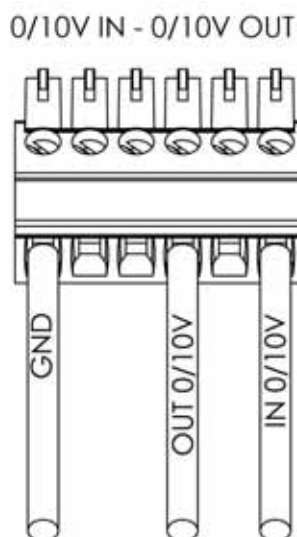

(6) IN 0/10 Volts - Control :

INPUT [V]	INPUT RANGE [V]	COMMAND
0,5	0 to 0,8	OFF
1,3	1 to 1,5	RESET BURNER *
2,5	2 to 2,8	FAN ONLY
4,5	3 to 5,8	LOW FIRE (PA)
8	6 to 10	HIGH FIRE (GA)

* for 2 seconds maximum

(4) OUT 0/10 Volts - Info :

OUTPUT [V]	OUTPUT RANGE [V]	INFORMATION
0,5	0 to 0,8	STOP
1,3	1 to 1,5	DEFAULT
3	2 to 4,8	RUNNING LOW FIRE (PA)
6	5 to 6,8	RUNNING HIGH FIRE (GA)
8,5	7 to 10	OVERHEATING FAILURE

0-10 Volts mode setting :



From the homepage,

Go to the page **SETTINGS TECHNICIAN QUALIFIED** by pressing the button ▲

Press during 3 seconds the button [OK] to open the menu



Go to the page **COMMUNICATION** by pressing ▲

MODBUS page

It displays : COMMUNICATION + xxxx BAUDS + OK or DEF
The unit are set for MODBUS use, a default (DEF) is displayed on the page.



To access to the others modes, press the button [OK] during 3 seconds.

The screen displays « MODI: » before the active mode.



Select the 0/10 Volts mode by pressing the buttons ▲ or ▼

When the selected mode is displayed, confirm by pressing the button [OK]

Hybride mode connection :

0/10V IN - CONTACT OUT

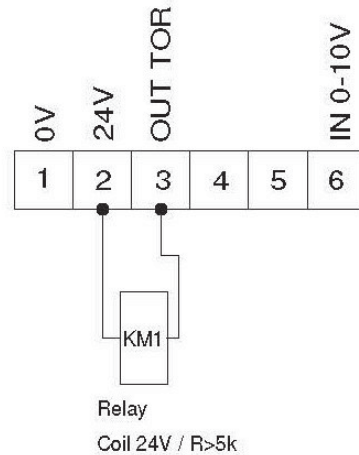
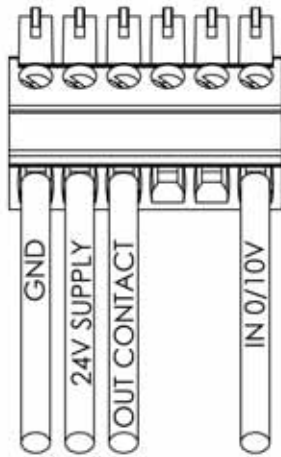

(6) IN 0/10 Volts - Control :

INPUT [V]	INPUT RANGE [V]	COMMAND
0,5	0 to 0,8	OFF
1,3	1 to 1,5	RESET BURNER *
2,5	2 to 2,8	FAN ONLY
4,5	3 to 5,8	LOW FIRE (PA)
8	6 to 10	HIGH FIRE (GA)

* for 2 seconds maximum

(3) OUT ON/OFF - Info :

Gas default, overheating default or sensor default

ON/OFF mode setting:

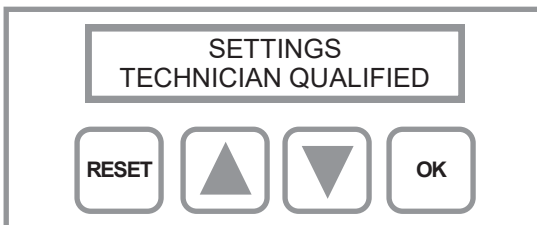

From the homepage,

Go to the page **SETTINGS TECHNICIAN QUALIFIED** by pressing the button

Press during 3 seconds the button [OK] to open the menu



Go to the page **COMMUNICATION** by pressing

MODBUS page

It displays : COMMUNICATION + xxxx BAUDS + OK or DEF
The unit are set for MODBUS use, a default (DEF) is displayed on the page.



To access to the others modes, press the button [OK] during 3 seconds.

The screen displays « MODI: » before the active mode

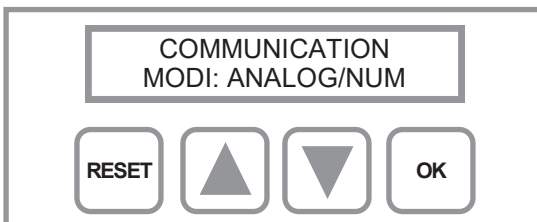

Select the 0/10V-ON/OFF mode by pressing the buttons or

When the selected mode is displayed, confirm by pressing the button [OK]

Numeric mode connection (ON/OFF) :

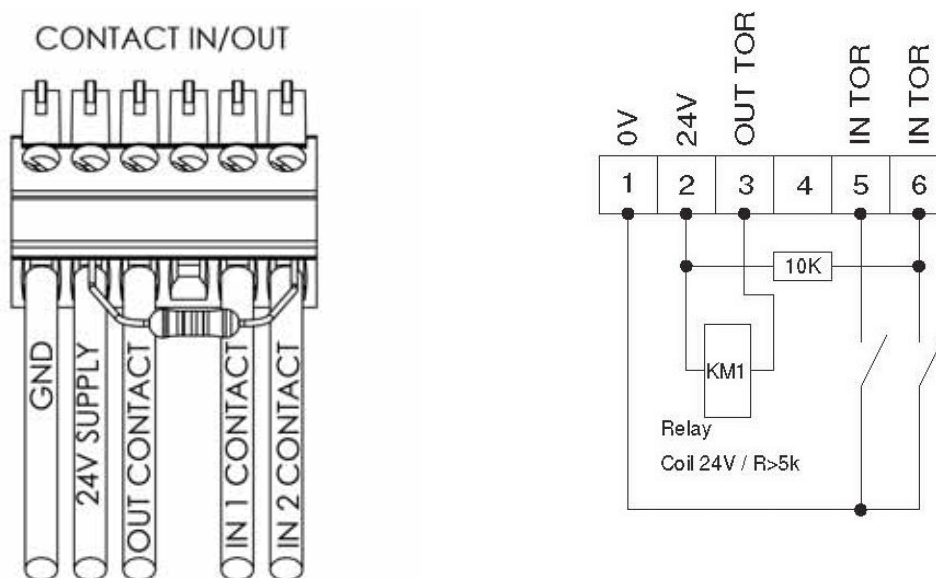

CAUTION : This type of connection requires a resistance of 10kΩ to place between (2) and (6).

(5) & (6) IN ON/OFF - Control:

INPUT 6	INPUT 5	COMMAND
OFF	OFF	OFF
ON	OFF	LOW FIRE (PA)
OFF	ON	HIGH FIRE (GA)
ON	ON	BURNER RESET *

(3) OUT ON/OFF - Info :

Gas default, overheating default or sensor default

Commute the customer relay with maximum power 100mW. If the relay consume more, use a second one of 100mW (example : Phoenix Contact RIF-0-RPT-12DC/21)

ON/OFF mode setting:



From the homepage,

Go to the page **SETTINGS TECHNICIAN QUALIFIED** by pressing the button

Press during 3 seconds the button [OK] to open the menu



Go to the page **COMMUNICATION** by pressing

MODBUS page

It displays : COMMUNICATION + xxxx BAUDS + OK or DEF
The unit are set for MODBUS use, a default (DEF) is displayed on the page.



To access to the others modes, press the button [OK] during 3 seconds.

The screen displays « MODI: » before the active mode



Select the 0/10 Volts mode by pressing the buttons or

When the selected mode is displayed, confirm by pressing the button [OK]

5- FLUE PIPE CONNECTION

5-1 Generalities

During the commissioning and the maintenance, make sure that:

- Combustion air intake and smoke exhaust are not obstructed.
- Seals are not damaged during the installation of the flue pipes, between them or on the unit. Ensure the tightness.

- There is no water which can come inside the unit by the flue pipes (electrical hazard). For this, use: drain tee, condensate drain pan,...
- For big extension and concentric installation, it is necessary to foresee a condensate drain pan.

5-2 Single flue kit connection

The combustion air is taken directly into the room and the smoke exhaust is done to the exterior thanks to a single flue through the roof. The fumes must be evacuated outside the heated room.

Roof type B22 Vertical

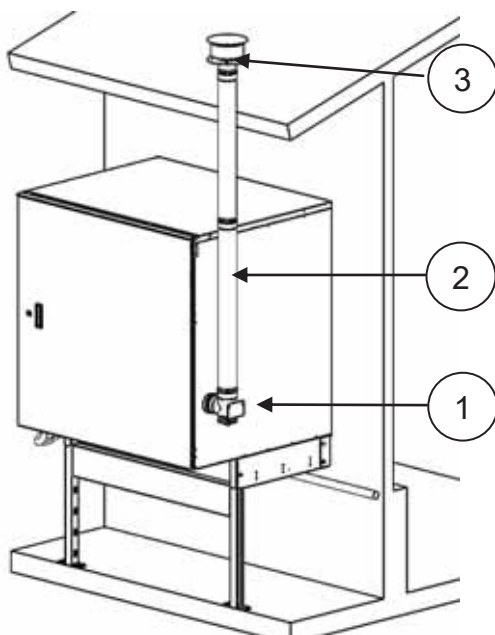

Mounting type :

Flue pipe diameter Ø80mm:

- Tee with airtight (1) at the beginning,
- Single extension of 1 m (2),
- Roof terminal (3)

The roof terminal must be minimum at the same height of the roof ridge.

Montage type :

Flue pipe diameter Ø80mm:

- Airtight terminal (1),

The horizontal evacuation must have an incline of 3° down to prevent any condensate to return to the fumes extractor.

B22 Horizontal

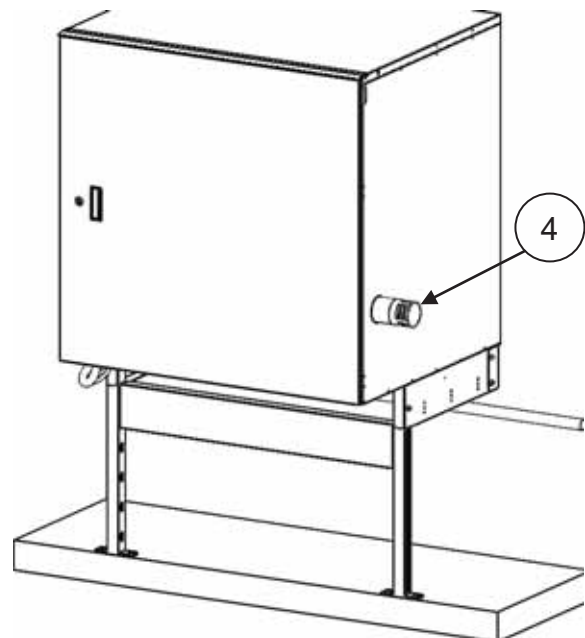

ATTENTION

The section of flue must be at least equal to the diameter of the heater outlet.

The smoke exhaust cannot be vertical or at 45° minimum.

The total length of the connection cannot exceed 4 m, knowing that : elbow 90° or 45° = 1 m of flue.

If the outside part of the flue is higher than 2 m, foresee an insulated pipe.

The evacuation must be outside for a good fumes evacuation.

Do not confine the evacuations, under a lean-to per example, risk of re-fume extraction from the device.

Make sure that the fumes are not reintroduced in the heated room, provide enough space regarding the ventilation hatches of the heated room.

6- GAS CONNECTION

6.1 Generalities

First of all it is necessary to check that the device is in conformity with the type of gas distributed. For this purpose, you must refer to the indications shown on the identification plate.

The gas supply must be appropriated to the power of the heater and be equipped with all the security and inspection devices required by current standards.

A precise study must be carried out on the diameters of the piping depending on the type and the flow of gas and the length of the piping. It is necessary to make sure that pressure drops in the piping do not exceed 5 % of the supply pressure.

The gas connections must be made in conformity with the recommendations for indoor installations whatever the type of gas, by qualified personnel holder of necessary approvals.

In case of LPG use, be careful with the evaporation capacity of the tank!

The evaporation capacity is linked to the dimension of the tank, to the pressure and to the outside temperature. The lower is the temperature and the starting pressure is high, the less is the evaporation capacity. So it means that the tank must be oversized regarding the real consumption needs.

Installation example : 3 heaters of 80 kW = 6.3 kg/h x 3 = 19 kg/h

- Gas pressure at 1.5 bar with outside temperature at -10°C : 10 tons tank for correct gas flow.
- Gas pressure at 500 mbar with outside temperature at -10°C : 3 tons tank is enough.

Caution: before opening the gas network, check the sealing up to the unit heater solenoid valve

6-2 Connection

The gas connection is made on male gas connection 3/4", located under the door of the device on the left side. Make sure that the passage for gas is clean and non obstructed (leaves, cobweb, soil, etc.)

Gas connection type :

A- Under 50 mbar natural gas supply (shut off valve + gas filter)

B- Over 50 mbar natural gas supply (shut off valve + gas filter + gas pressure regulators)

C- LPG supply (shut off valve + gas filter + gas pressure regulators)

Gas connection kit*

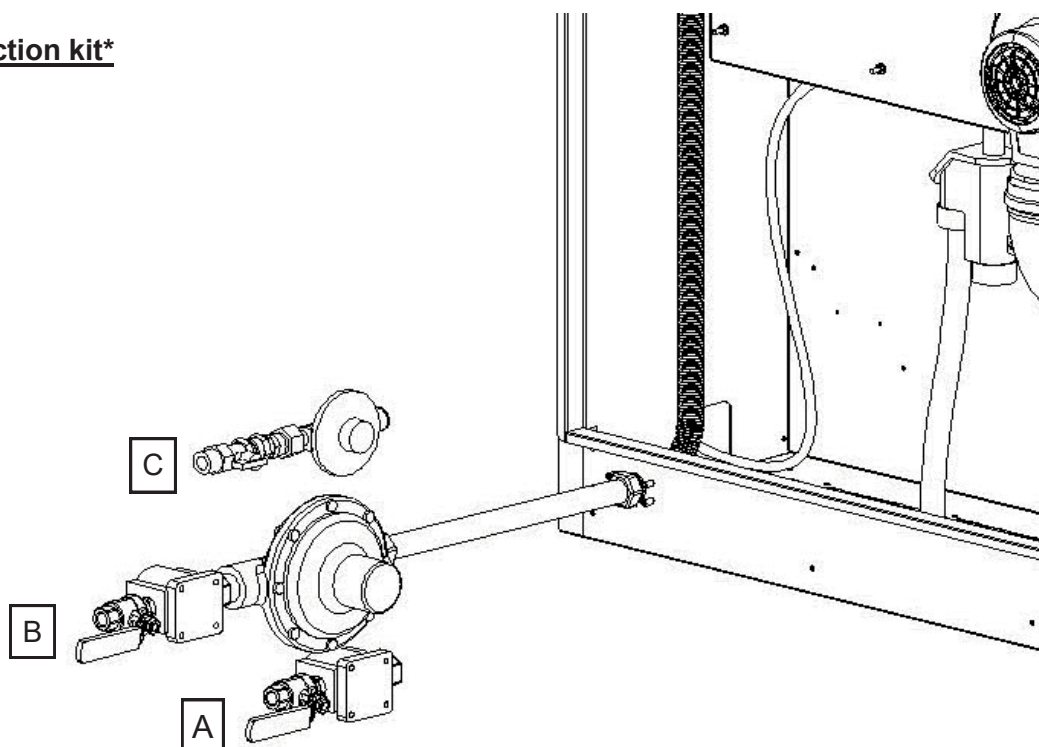

For more detail on kit gas, refer to their notice.

7 - COMMISSIONING

7-1 Commissioning

1– Before starting the commissioning and powering the device, check the different connection if they have been properly installed, especially :

- Air intake connection and ventilation grille
- Gas connection,
- Electric connection, ground safety connection ...

Also check :

- That the connection (gas and combustion air) are perfectly sealed
- That the protective film on panels is removed
- That the distances around the generator are respected
- That the fan door is locked and the electrical fan plug is properly connected

2– Check the electricity supply, between 210V et 230V alternative, be careful of the neutral phase polarity. For neutral "impedance" , please provide an unbiased control box.

3– Check if the gas type correspond to the device, with a maximum pressure of 50 mbar, refer to the chapter « Gas Connection ».

4– Check the connection with the controller.

5– Commissioning the generators.

- Open the gas valve and purge the pipes.
- Open the shut off valve for each device.
- Check if the electrical isolators proximity devices are set on ON (if available).
- Check if the louvers are unobstructed.

Two types of functioning are possible, check on the unit dashboard (refer to chapter « messages and functions »)

In automatic mode :

The device receive the working instructions from the controller, ON/OFF and burner in low or high speed.

- On the controller, set up the set point temperature to 1°C more than the ambient temperature into the building.

- The device is starting.

As following page flowchart is explaining, the device manages the speed of the burner regarding two adjustable temporizations : timer of burner on and timer of burner off.

⇒ In case of heating demand in low speed by the customer regulation, burner start in low speed.

⇒ In case of heating demand in high speed by the customer regulation :

- If the device was in high speed at the end of the previous heating and if the timer of burner off is lower than Y min, **the device starts in high speed** (the power need is justified).
- If the device was in high speed at the end of the previous heating and if the timer of burner off is higher than Y min, the device starts in low speed and will switch to high speed after X min (if the device stops before reaching X min, power need was not justified)

X and Y are adjustable between 5 min and 15 min on the device in the section SETTINGS TECHNICIAN QUALIFIED (X=TIME GA ON et Y=TIME GA OFF, see 10-5d and 10-5e, p. 36)

Working principle

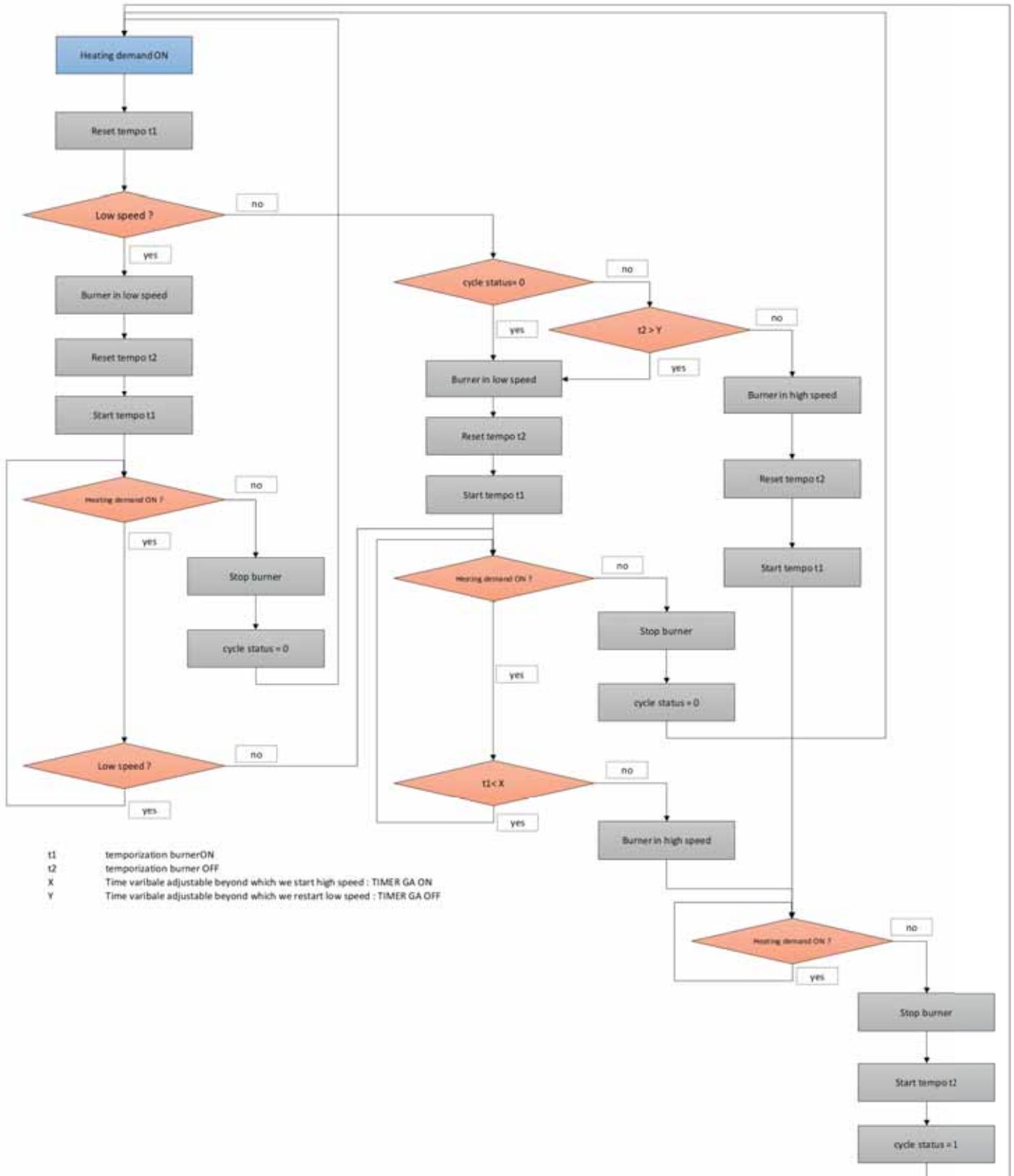

In manual mode :

The device operates autonomously. The set point temperature is set on the device (refer to “manual mode settings”). The air intake sensor (1) manage the ON/OFF functioning and the switch automatically from low to high speed

-Set up the set point temperature (TC) to 1°C more than the ambient temperature into the building.

- The device is starting.

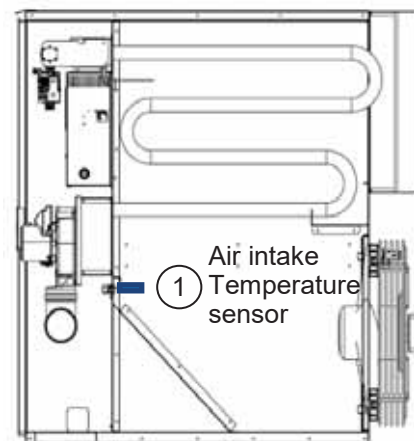

6- Proceed gas safety test by closing the gas inlet, the unit must turn off and make three start attempts before switching to safety. Reset the device on the controller or thanks to the digital screen on the card of the device, refer page 21, then proceed the same test by remotely resetting.

7- Turn the device on the desired mode, automatic or manual, and set the desire setpoint.

7-2 Operating mode

The unit is equipped with a display and tactile button to navigate in the different menu. When the unit is powered up, the state of the device is displayed. If there is any fault on the system, it is displayed on the main screen.

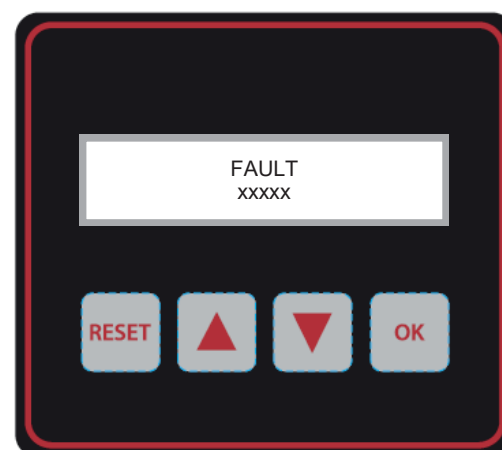
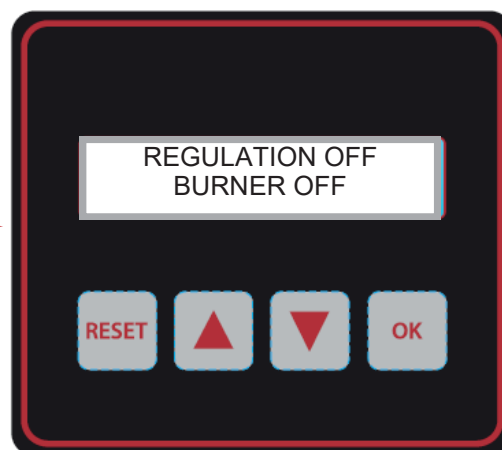

For more details on fault signal, refer to the chapter« [10-2 « fault display »](#) »

7-2a Messages et fonctions :

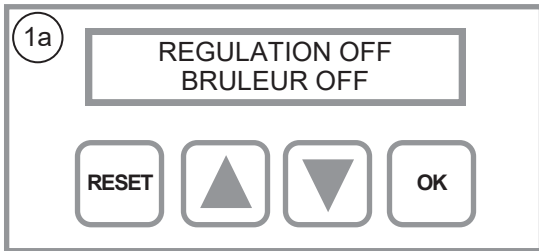

1– Home screen, several possible messages :

1a– No heating demand from the controller, the burner is OFF

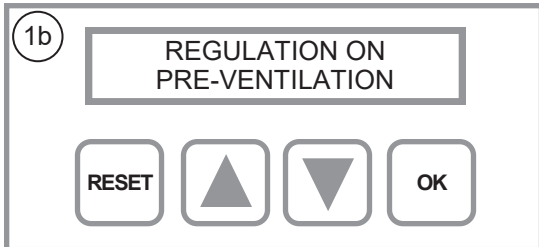

1b– The controller asks for heating, the device starts its ignition cycle. It starts the pre-ventilation of the heat exchanger (the exhaust fan is working).

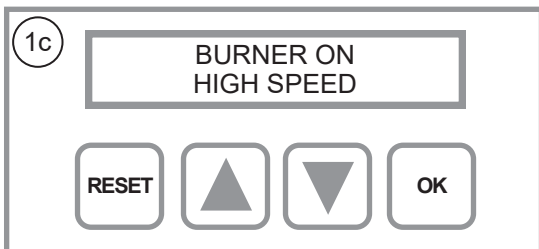

1c– The controller asks for heating in high power speed. The device is working (Burner in high speed).

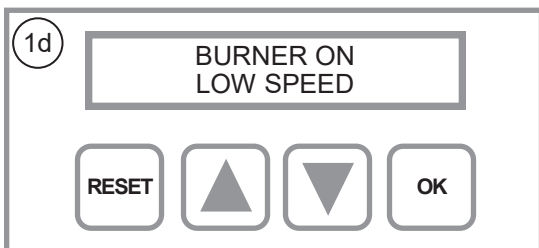

1d– The controller asks for heating in low power speed. The device is working (Burner in low speed).

When the device displays one of those screens, by pressing on the buttons ▲ or ▼, we access to the different pages which control the device.

Press the button ▲

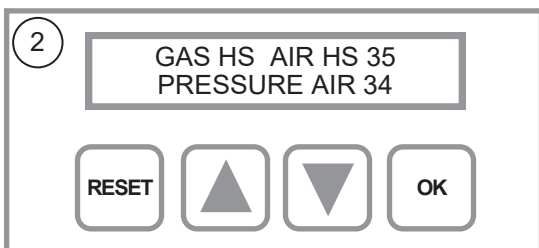

2- **GAS** indicates the speed of the burner (**HS** = High Speed or **LS** = Low Speed) and **AIR** indicates the speed of the exhaust fan. The value (**35**) indicates the requested pressure in Pa, this value is a factory setting.

PRESSURE AIR Indicates the value given by the pressure sensor in real time (here **34** Pa), this value can fluctuate.

Press the button ▲

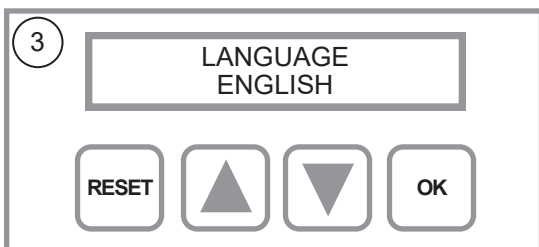

3– This screen is to select the language. It can be modified, refer to page No. 23.

Press the button ▲

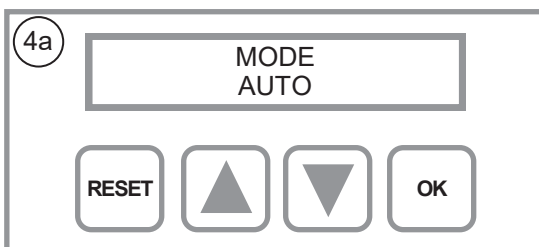

4a– Operation mode of the device in AUTO MODE (automatic)

The controller send the working order to the device (Working set point HS or LS, ambient temperature)

OR

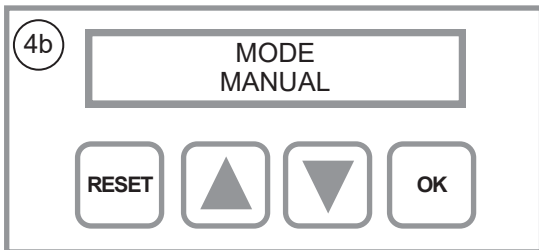

4b- Operation mode of the device in MANUAL MODE

The device operates autonomously thanks to an integrated sensor in the air intake and depending on the required temperature. The speed of the burner (low speed or high speed) is managed by the device itself.

Press the button 

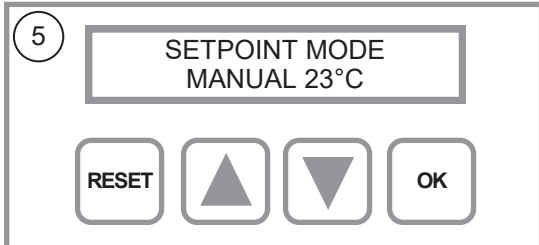

5- Required set point temperature in MANUAL operation mode. This value can be modified, refer to page No. 24.

Press the button 

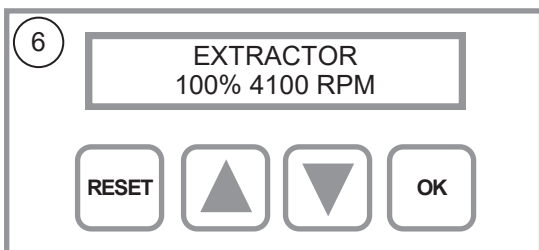

6- This screen indicates the operating state of the exhaust fan. You can read the required percentage of power and the rotation per minute.

Press the button 

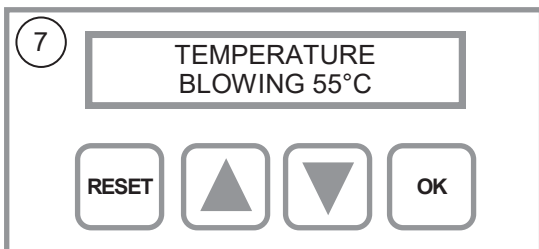

7- This screen indicates the blowing temperature of the device. The indicative value is indicated by the sensor located in the flow of air at the back of the heat exchanger.

Press the button 

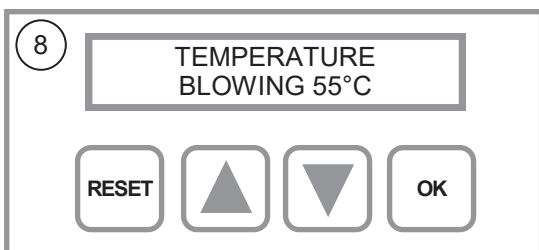

8- This screen indicates the temperature which starts the blowing fan. This value can set, refer to page No. 25.

Press the button 

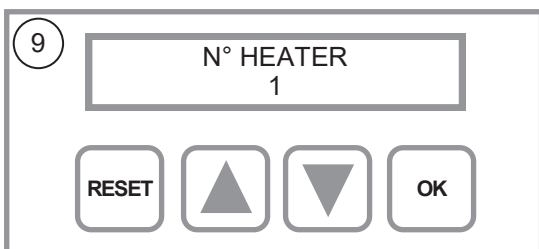

9- This screen displays the No. (address) of the device. It allows the unit to dialogue with the controller. On the same one controller, 2 same addresses can create a communication conflict. If it is needed, this number can be modified, refer to page No.26

Press the button 

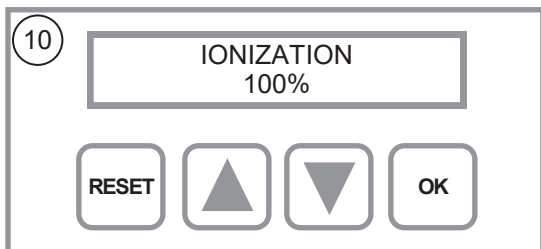

10– This screen indicates the ionization value of the burner. If the unit stops, the value displayed is NONE.

Press the button

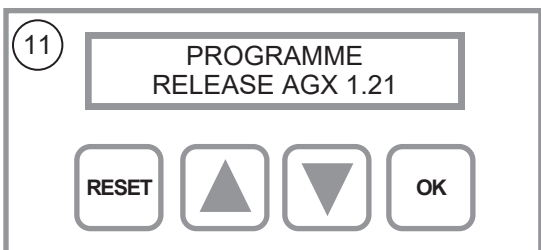

11– This screen indicates the version of the program.

Press the button

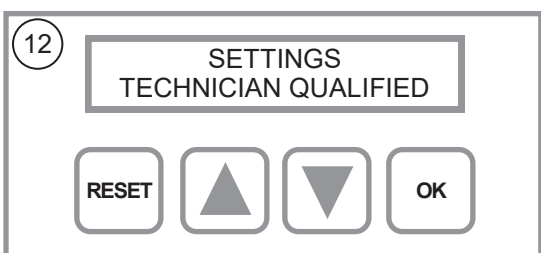

12– This screen gives the access to the technical settings of the device.



THIS MENU GIVES ACCESS TO FACTORY SETTINGS, THE ACCESS IS RESTRICTED TO AUTHORIZED AND QUALIFIED USERS.

Press the button to go back to the screen No.2

To return to the main menu, wait 1 minute without any action on the keypad and without pressing

7-2b LANGUAGE settings

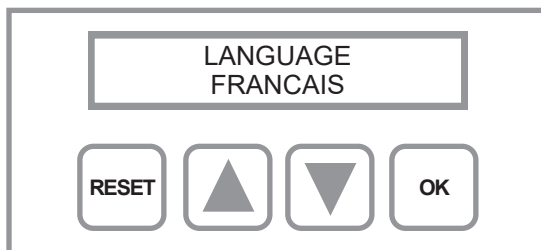

From the main menu,

Go to the screen **LANGUAGE** by pressing

Selection of language:

To modify the language, press [OK] during 3 seconds

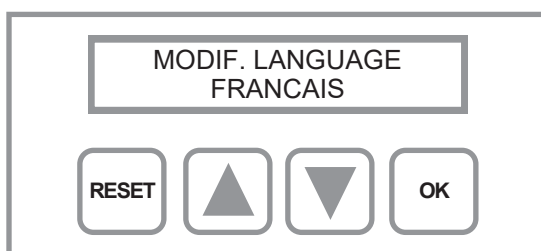

Select the language with the buttons ;

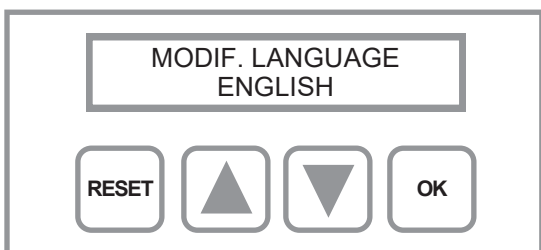

When the selected language is displayed, validate by pressing the button [OK]

7-2c AUTO and MANUAL Mode settings

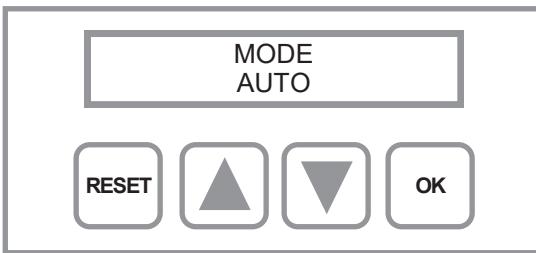

From the main menu,
Go to the screen **MODE** by pressing

Operating mode selection:
To modify the language, press [OK] during 3 seconds

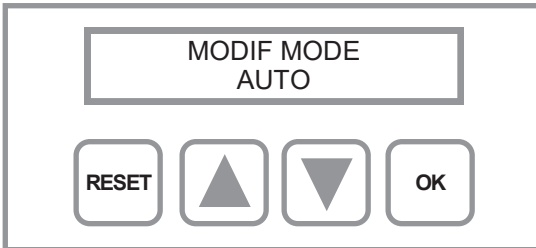

Select the mode with the buttons ;

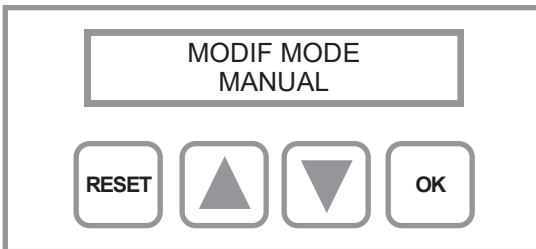

When the selected mode is displayed, validate by pressing the button [OK]

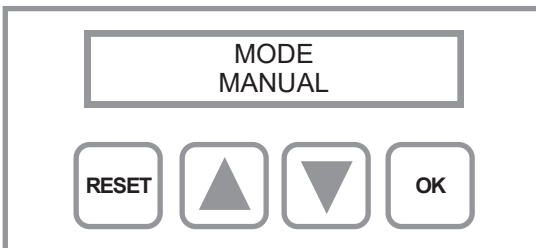

The **MANUAL MODE** is now activated.

To return to **AUTO MODE**, use the same procedure.

7-2d Temperature settings for MANUAL MODE

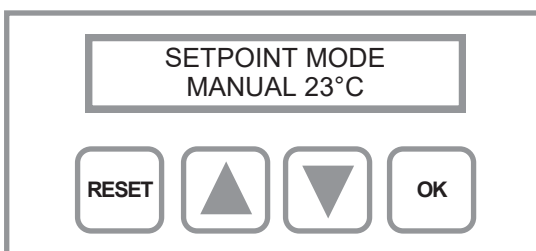

From the main page,
Go to the screen **SETPOINT MODE** by pressing
Temperature settings:
To modify the language, press [OK] during 3 seconds

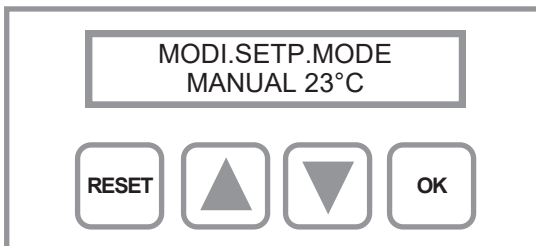

Select the temperature with the buttons ;
Temperature can be set up from 10°C to 37°C

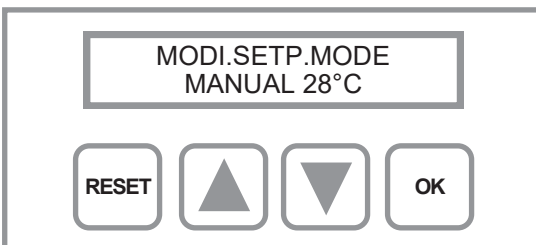

When the selected temperature is displayed, validate by pressing the button [OK]

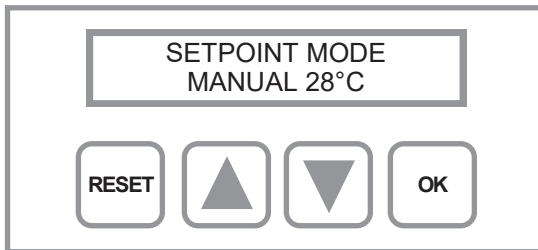

The setting is activated if the **MANUEL MODE** is selected, refer to previous chapter.

7-2e Temperature settings to start blowing

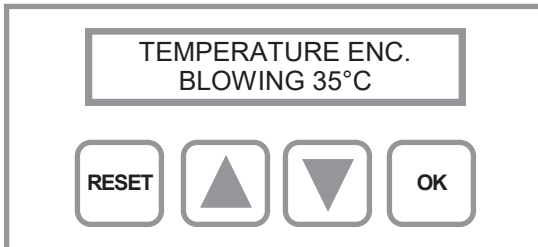



From the main page,

Go to the screen **TEMPERATURE ENC. BLOWING** by pressing .

Fan activation by temperature settings:

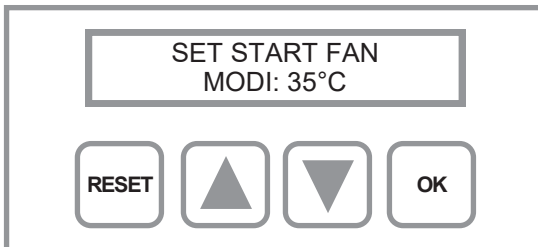
To modify the language, press [OK] during 3 seconds



Select the temperature with the buttons ; 

Temperature can be set up from 30°C to 45°C

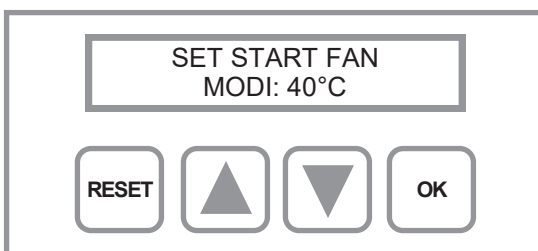

When the selected temperature is displayed, validate by pressing the button [OK]

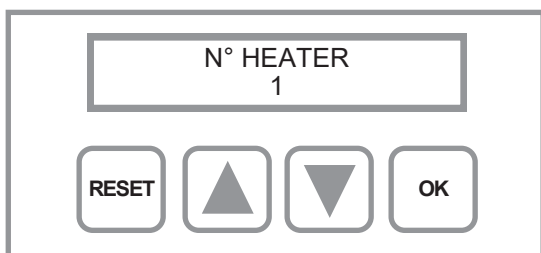

7-2f Device address settings

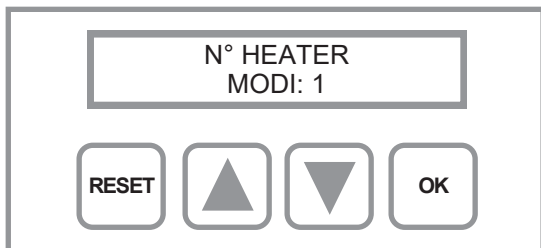

From the main page,
Go to the screen **N° HEATER** by pressing 

Selection of Unit Number:
To modify the language, press [OK] during 3 seconds



Select the No. Of the unit with the buttons ; 

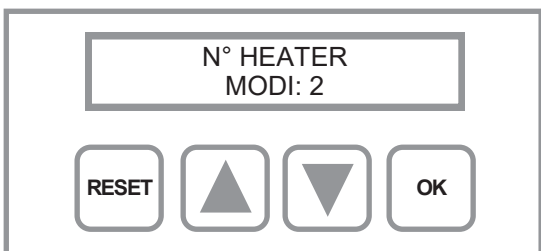

When the selected device No. is displayed, validate by pressing the button [OK]

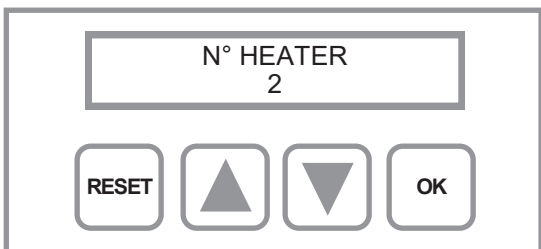

On the same installation, each device must have a different address/number (N°HEATER) to be able to communicate with the controller.

7-4 BILL OF MATERIALS

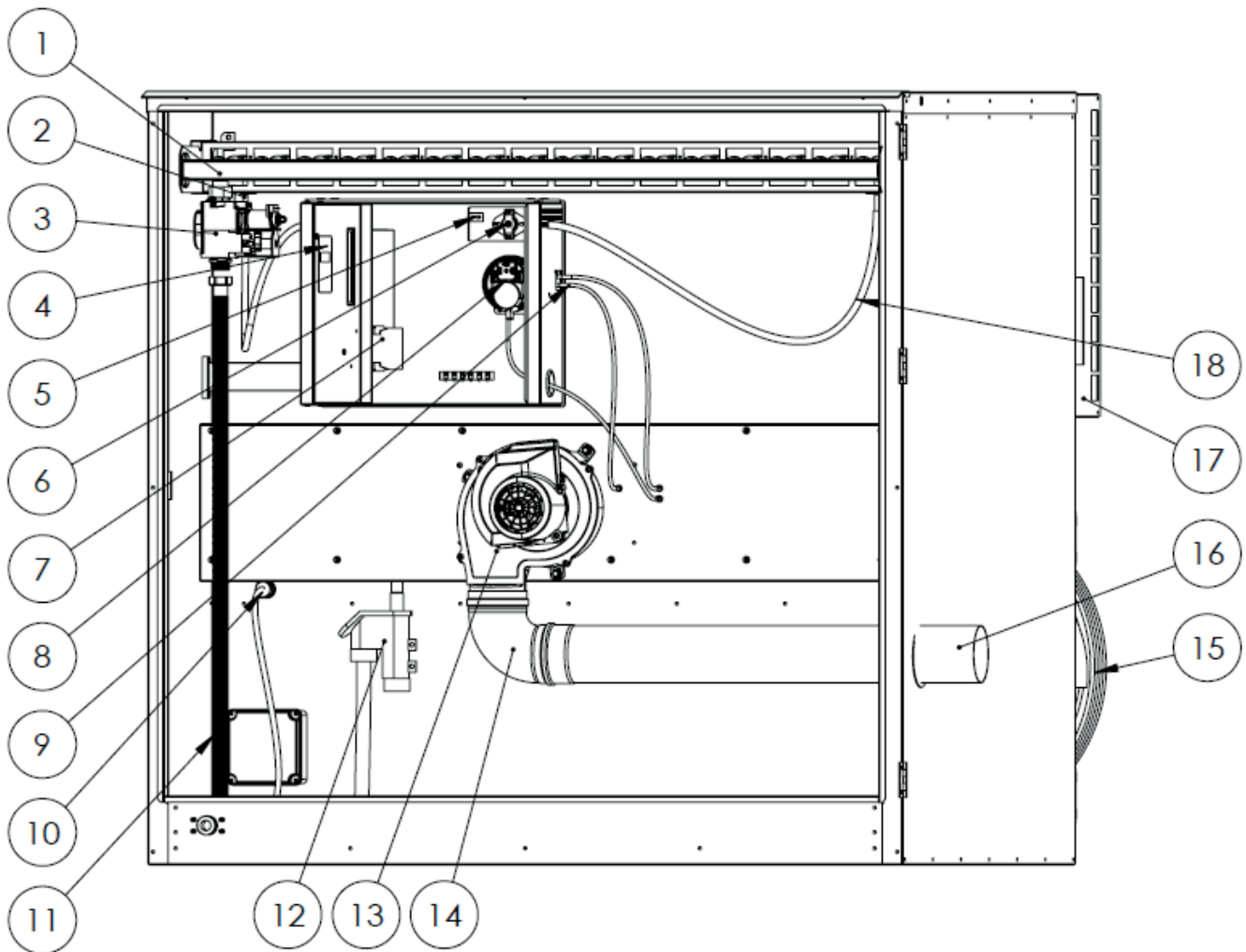

No.	Description	AGX55	AGX85
1	Gas ramp / TYPE OF GAS	Consult us	Consult us
2	Ignition electrode + cable	ATE021+ATE408-BLANC	
3	2-stages solenoid gas valve	GAZ0014	
4	Electronic PCB	REG240AGX	
5	Temperature sensor of heat exchanger	HB0087AGX	
6	Safety thermostat with manual reset	THE147	
7	Contactor 4P 230V-16A	ELE0313	
8	Differential air pressure switch 80-60 Pa (Blue)	ATE226	
9	Differential pressure sensor	ATE463AGX	
10	Return air temperature sensor	ELE0247AGX	
11	Flexible gas 3/4"	FLEXIND120	
12	Siphon	UTC0448	
13	Exhaust fan	ATE0101	
14	Elbow 90° Ø80 ALU	CE8090	
15	Axial fan	1x ATE804S	2x ATE804S
16	Sealed tube Ø80 mm	LE80050	LE80065
17	Diffuser with profiled louvers	SEDIFAGX55	SEDIFAGX85
18	Ionization sensor + cable	ATE022 + ATE025-BLANC	

8- CHANGE OF GAS

The gas heater units are equipped with atmospheric flared gas burners, which allow to use natural gases G20, G25 or even LPG

The burner ports are designed to ensure a very good flame stability without separation nor return to the injectors.

THESE INTERVENTIONS MUST BE PERFORMED BY A QUALIFIED PROFESSIONAL.

The gas change must be realized in the following way :

- 1- Disconnect the electric supply connector and close the gas supply
- 2- Unscrew the fixing nut of the gas network (Rep 1.) on the gas valve and the three screws (Rep. 2) which allow the injector ramp to be fixed on the burner block.
- 3 - Change the injectors (see the settings table).
- 4 - Screw the new injectors (Rep 3.) replacing the sealing rings (Rep 4.) and keeping an eye on the sealing, **the injectors must be assembled dry.**
- 5 - Reassemble the ramp and reconnect the gas network on the gas valve **by replacing the gasket,** careful during the reassembly don't forget, or damage, the sealing rings.
- 6 - **Control the sealing after the assembly.**
- 7 - Adjust the gas pressure on the ramp via the gas valve.

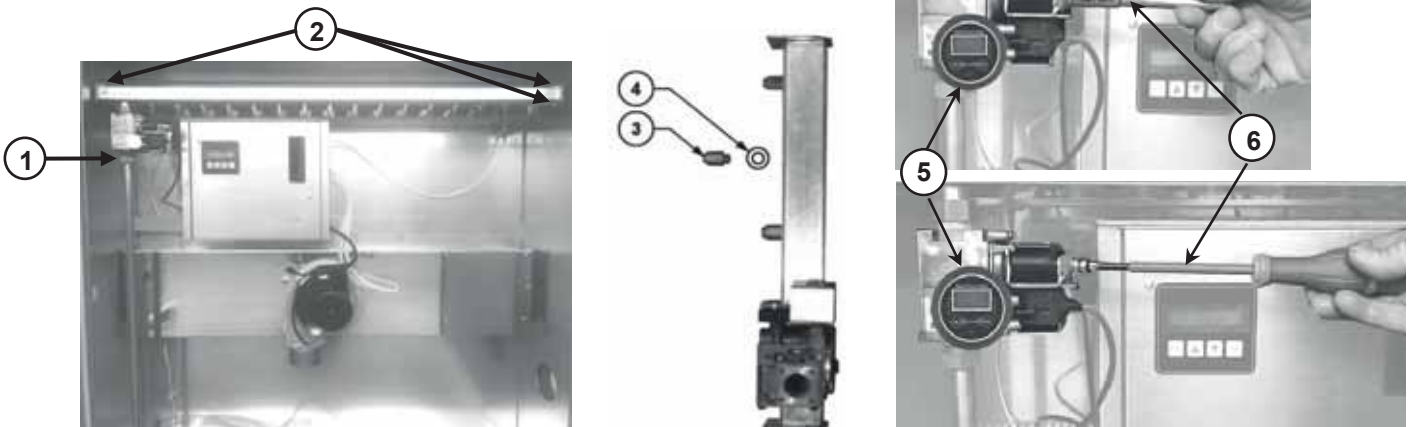

CAUTION : This operation must be realised with gas and electricity cut.

The gas pressure is adjusted when the burner is in operation

The gas pressure is adjusted as follows:

- 1- Remove the protection screw from the pressure set of the solenoid valve.
- 2- Unscrew the pressure outlet, connect the manometer (5)
- 3- Take off the plastic plug, and set the ramp pressure (6) following the setting table.
 - High speed : 10mm wrench
 - Low speed : screwdriver (big size)
- 4- **After adjustment, do not forget to put the screw protection back and close the pressure intake.**
- 5 - **Control the sealing after the adjustments**

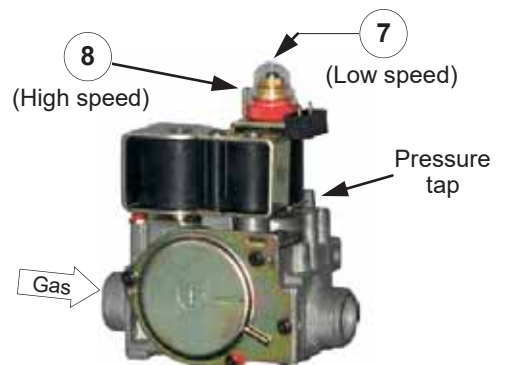

Types	Adjustment for G20			Adjustment for G25			Adjustment for G31		
	Regulator pressure [mbar]		Gas ramp injectors Number/Ø	Regulator pressure [mbar]		Gas ramp injectors Nber/Ø	Regulator pressure [mbar]		Gas ramp injectors Nber/Ø
	Low speed	High speed		Low speed	High speed		Low speed	High speed	
AGX55	4	8.5	10 x AL 2.20	5	10.5	10 x AL 2.20	12.5	25	10 x AL 1.30
AGX85	4	8.5	16 x AL 2.20	5	10.5	16 x AL 2.20	12.5	25	16 x AL 1.30

9-MAINTENANCE

Correct and regular use and maintenance of the unit heater allows an efficient operation, a minimum consumption, as well as a long life.



These interventions must be realised by a qualified person.

THE MAINTENANCE MUST BE DONE WITH THE DEVICE COLD, WITH THE GAS AND ELECTRICITY SUPPLIES CUT OFF.

The heaters used for poultry houses must be cleaned and maintained more frequently.

It is necessary to clean the device each time a change is made to a new batch! It is also required to check the combustion at least twice a year.

Check the proper functioning of all safety devices and check that all screws are correctly tightened.

Heat exchanger, smoke extractor and venturi :

To access to the heat exchanger, dismount the smoke box and the burner. Inspect the state of the tubes inside, and if it necessary, clean and sweep it. If the heater is equipped with smoke baffles, check their state before reassembling them, if it is necessary replace them.

Make sure to replace all damaged seals during this operation. Clean the exhaust fan and the venturi with a soft cloth and/or compressed air.

Gas burner:

Dismantle the burner, check the burner ramp state and the nozzles and clean it.

Check the state of the ionization sensor and ignition electrode, their position in relation the burner ramp and change them if it is necessary. If the heater is equipped with NOx catalyser, check their state regularly and replace them if necessary. They must be replaced at least each two years.

Gas filter :

Dismantle the dirty cartridge and clean it with compressed air.

Flue pipe :

Dismantle the pipe, sweep it and check leaks.

Blowing fan:

Before cleaning the device, disconnect the "Harting" electrical plug of the fan(s) before opening the door. If it is needed, it is possible to remove completely the door to avoid any water projection when you clean the heat exchanger or the farm. Clean the fan(s) **with compressed air, never use a high-pressure jet of water.**

Body and grilles :

Clean it using a duster.

Outside of the heat exchanger:

The heat exchanger can resist to a high pressure cleaner and can be cleaned with clean water, **without additive.**

After cleaning, make sure to dry properly the device to avoid stagnant water, that can create an oxidation in reaction with volatile compounds into the farm.

The grill can be remove to facilitate the access to the exchanger and clean it. Make sure to do not spray the exchanger from the front, keep the head of high pressure jet on the side to allow a good angle to clean the heat exchanger. The water will flow towards the lower access door.

Be careful, during the cleaning, do not spray through the crimping base of the exchanger, there is a risk of infiltration into the combustion circuit.

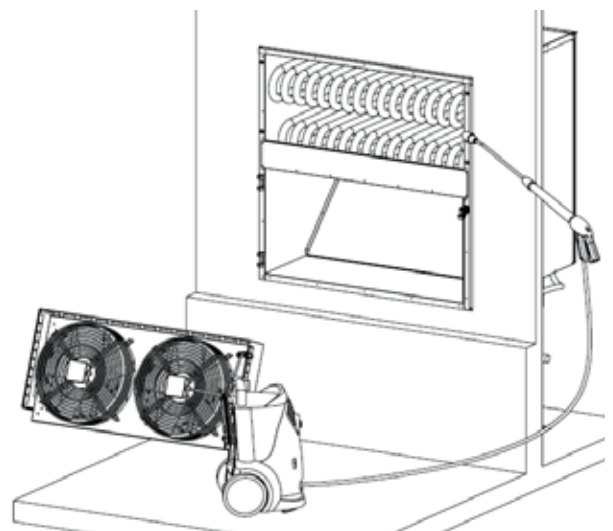

CAUTION:



Do not clean the burner compartment or the fan(s) with high-pressure jet of water!

Do not get wet the electrical parts, ELECTRICAL HASARD !

Do not spray through the fan(s).

Do not spray directly on temperature sensors

10- TROUBLESHOOTING

In case of problems, make sure that the conditions required prior to operating the heater are present. If the control box is in the safety position (with the burner defect indicator lamp lighted up), reset it.

CAUTION : All electrical or mechanical operations must be carried out when the electrical supply is cut off and the gas supply is closed.

10-1 Diagnostics and defaults:

Defaults	Causes	Things to do
The device does not start	<ul style="list-style-type: none"> - Incorrect wiring - Lack of voltage - Wrong connections - The ambient thermostat is not triggered, or no 0-10V signal - The pilot wire receptor is not on automatic position - Overheat safety thermostat is triggered. 	<ul style="list-style-type: none"> - Check the wiring - Verify the electrical supply - Control the connections - Increase the setting point of the ambient thermostat - Reset the thermostat
The burner preventilates continuously	<ul style="list-style-type: none"> - Extractor out of services - Air pressure switch disconnected - Air pressure switch out of services - Pressure air pipes cluttered 	<ul style="list-style-type: none"> - Replace the extractor - Reconnect the pressure air pipes - Check and/or replace the air pressure switch
The ignition electrode is sparking, the burner ignites, the control box turns on safety position (the burner default lights)	<ul style="list-style-type: none"> - Gas valve defective - Control box defective - Ionization sensor incorrectly adjusted or defective - Air in the piping - no gas 	<ul style="list-style-type: none"> - Replace it - Replace it - Adjust it or replace it - Bleed the piping - Check the pressure
The unit is on safety position (red led switched on)	<ul style="list-style-type: none"> - Gas supply interrupted 	<ul style="list-style-type: none"> - Reset by pressing the red button on the control box
The device does not heat sufficiently	<ul style="list-style-type: none"> - Incorrect placing of the thermostat - Incorrect adjustment of the thermostat - Insufficient gas pressure - Injectors are unsuitable 	<ul style="list-style-type: none"> - Change its location - Adjust the thermostat - Check the gas supply pressure - Check that the injectors are correctly selected and replace them if necessary
The device never stops	<ul style="list-style-type: none"> - Thermostat is set too high or is defective - Incorrect wiring 	<ul style="list-style-type: none"> - Lower the setting point or replace it - Check the wiring

10-2 Fault display

Be careful, before resetting the default, check the unit to understand where comes from the problem and so the default, refer to the chapter « troubleshooting ».

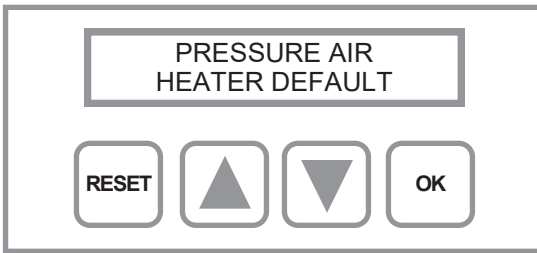

10-2a AIR PRESSURE FAULT

It does not detect the air pressure sensor,
- electrical problem (bad electrical connexion),
- Sensor out of service

When the problem is solved, the default is automatically resetting.

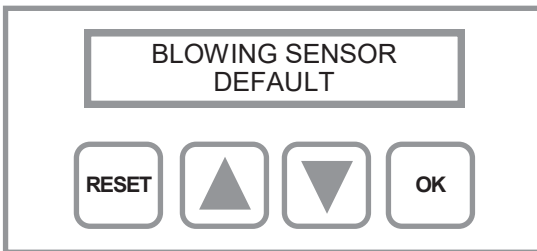

10-2b BLOWING SENSOR FAULT

It does not detect the sensor,
- electrical problem (bad electrical connexion),
- Sensor out of service

When the problem is solved, the default is automatically resetting.

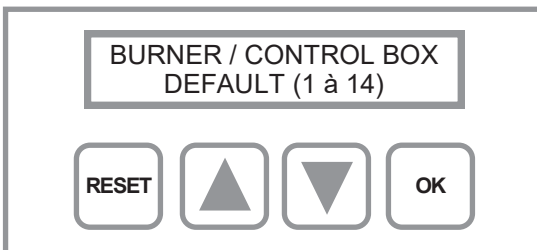

10-2c BURNER AND CONTROL BOX FAULT

This screen displays the burner faults by a number. The number corresponds to the diagnostic error.

During the start cycle, the system check the different safety devices.

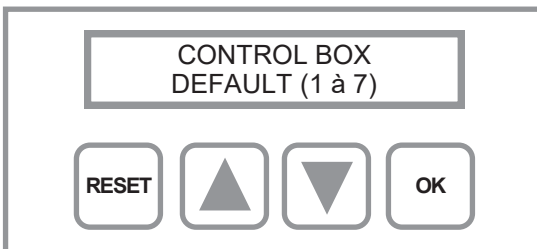

The errors from 1 to 7, are linked to safety tests during the pre-ventilation of the exhaust fan.

BURNER DEFAULT 1 to 2 : Ionization test

BURNER DEFAULT 3 to 6 : Solenoid gas valve relay test

BURNER DEFAULT 7 : Solenoid gas relay Communication test

To reset the default, press the button [RESET] or automatic reset each 15 min

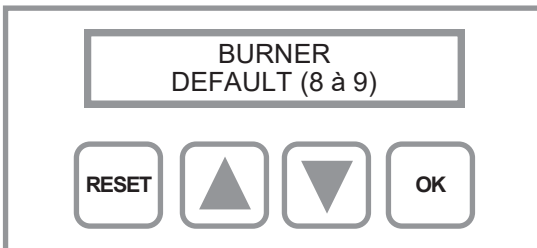

The errors from 8 to 9, are linked to a pressure sensor test.

BURNER DEFAULT 8 : The sensor detects an air pressure whereas it should not have.

BURNER DEFAULT 9 : The sensor does not detect air pressure whereas it should have.

Default reset by pressing [RESET] button only

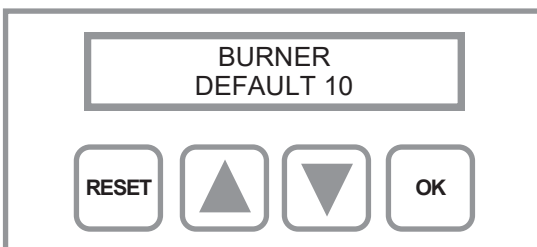

BURNER DEFAULT 10 :

Ignition burner fault, after 3 ignition attempts.

- Gas supply problem : check the gas valve opening, the gas supply, the nature of gas, the gas pressure in ad out of the solenoid gas valve,...

- Flame detection problem, check the ionization.

Default reset by pressing [RESET] button only

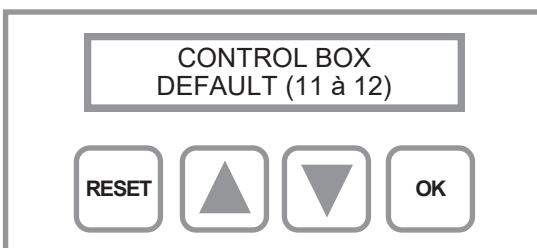

CONTROL BOX DEFAULT from 11 to 12 : the error is linked to the intern dialogue between the microcontrollers of the electronic PCB.

To reset the default, press the button [RESET] or automatic reset each 15 min

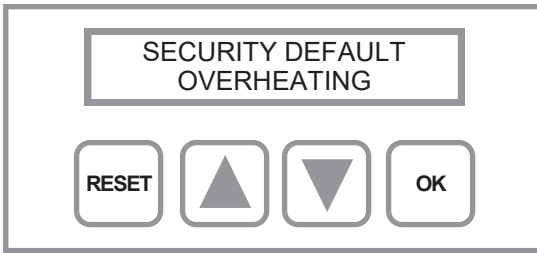

10-2d OVERHEAT DEFAULT

The thermostat with manual reset is on safety. It must be reset manually.

This error is linked to a bad cooling of the heat exchanger. The reasons can be: fan(s) out of service, obstruction of suction or blowing side, fouling problem, etc.



This default must be reset by a qualified person with necessary approvals. In-depth research must be realized to detect the causes of the default.

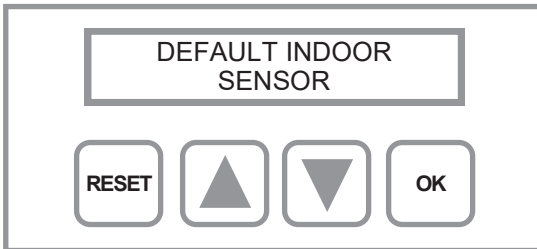

10-2e AMBIENT SENSOR FAULT

This default concerns the ambient sensor placed in the air intake, refer to the chapter « OPERATING MODE », and only when the device is used in MANUAL MODE.

- electrical problem (bad electrical connexion),
- Sensor out of service

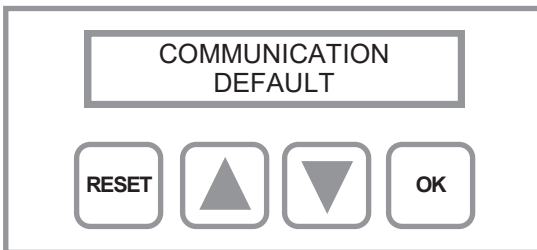

10-2f COMMUNICATION FAULT

This default concerns the communication between the device and the controller or the dialogue interface.

- Electrical connexion problem
- Bad cable insulation
- Inappropriate communication cable (non-shielded cable, electrical cable use,...)
- Inappropriate wiring, check the order of pairs, check that the wiring is in series not in parallel, etc.

10-3 Air pressure switch replacement

Thanks to the information given by the air pressure switch to the electronic PCB, the exhaust fan adapts its speed to ensure the good setting depending on the burner speed (high/low speed). The replacement of the air pressure switch requires a calibration and balancing of high and low speed. Those operations are realized from the following menu « SETTINGS TECHNICIAN QUALIFIED» where there is the factory settings.



Be careful, if you change the factory settings may lead to a malfunction.

This intervention must be realised by a qualified person, trained to the product specifications.



The air pressure switch must be equipped with red pressure restrictors **from both sides!**



The calibration of the sensor must be realized when the device is stopped.

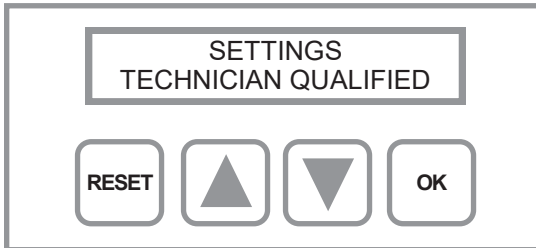

From the main page,
Go to the screen **SETTINGS TECHNICIAN QUALIFIED**
by pressing

Press [OK] during 3 seconds to open the menu.



The screen displays x PA = air pressure read , 0 PA if the device is stopped

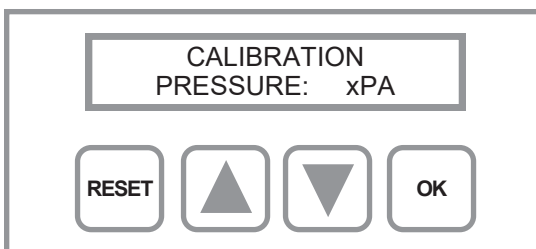

Go to the screen **CALIBRATION** by pressing

Press continuously the button [OK] until the value 0 is displayed.

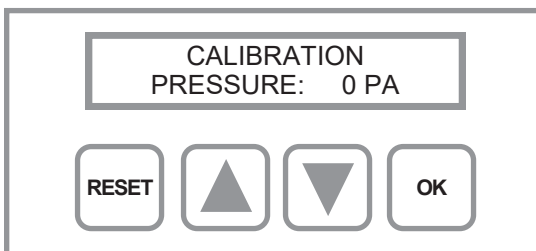

Release the button [OK], when the value 0PA is displayed, the calibration is acquitted.

**Then it is necessary to calibrate the speed of the burner.
For this operation the device must be operating!!**

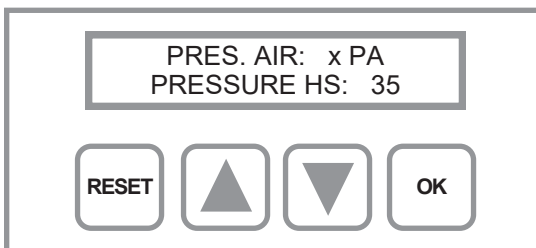

Go to the screen **PRESSURE HS** by pressing

The screen displays PRESS. AIR: x PA, air pressure read and PRESSURE HS: 35, which is the setting factory value.

Press [OK] during 3 seconds to start the calibration.

The screen displays PRESS.AIR : x PA, the read value during calibration and SETTING HS: 35, the value to reach.

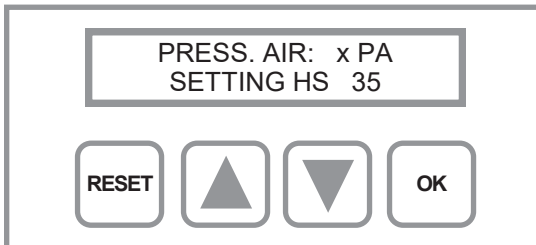

The device starts and calibrates the high speed.

When the value PRESS. AIR: xx PA, stabilizes to the requested value, a fluctuation is acceptable, validate the calibration by pressing the button [OK]

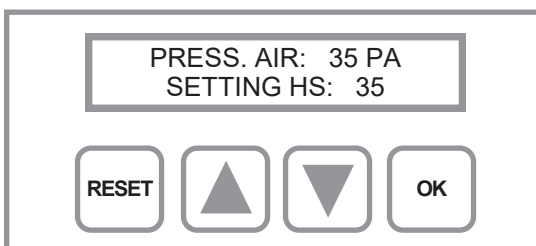

The device stops.

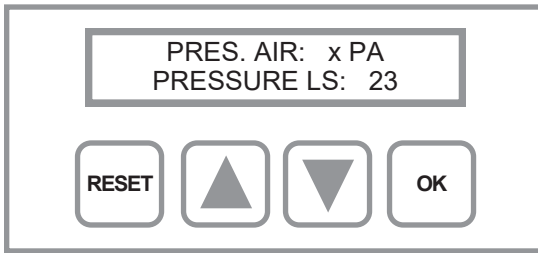

Go to the screen **PRESSION LS** by pressing 

The screen displays PRESS. AIR: x PA, read pressure and PRESSION LS: 23, which is the factory setting value.

Press [OK] during 3 seconds to start the calibration.

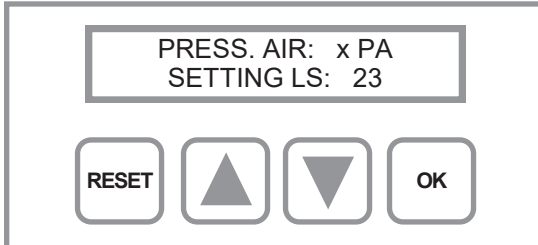

The screen displays PRESS.AIR : x PA, the read value during calibration and SETTING LS: 23, the value to reach.

The device starts and calibrates the low speed.

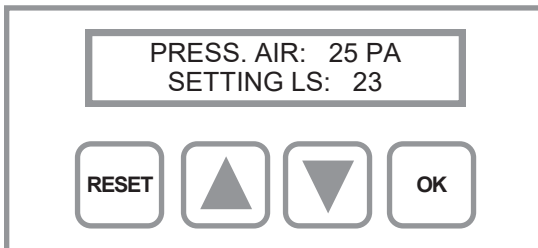

When the value PRESS. AIR: xx PA, stabilizes to the requested value, a fluctuation is acceptable, validate the calibration by pressing the button [OK]

The device stops.

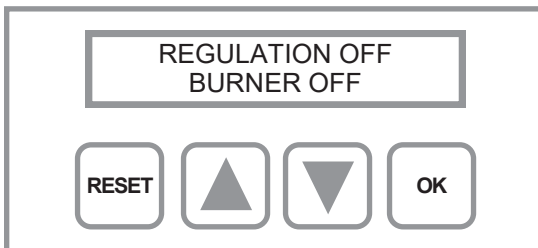

To return to the main page, press the button 

10-4 Electronic PCB replacement

The replacement of the electronic PCB requires to reattribute the address of the device (N° HEATER) and to calibrate the air pressure sensor.

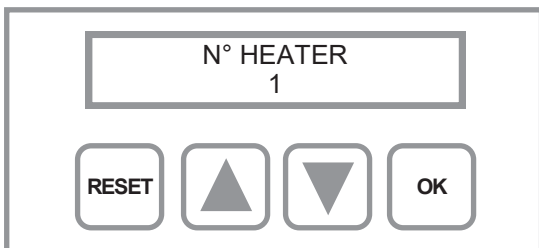

1st Operation

Address of the device (refer to chapter « Device address setting)

Make sure to give the same number than the previous one. Otherwise, the device will not be recognized by the controller. If you don't remember the previous number of the device, you can change and give a new number to all devices.

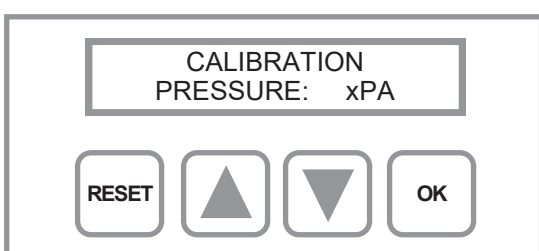

2nd Operation

Calibration of the air pressure sensor (refer to chapter « Air pressure switch replacement »)

10-5 SETTINGS TECHNICIAN QUALIFIED

Some situation require to modify the factory settings, you can find below the different parameters that can be modified.



Be careful, if you change the factory settings may lead to a malfunction.

This intervention must be realised by a qualified person, trained to the product specifications.

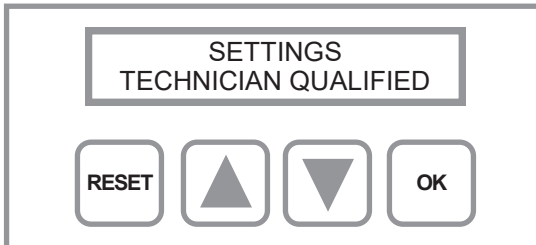

From the main page,
Go to the screen **SETTINGS TECHNICIAN QUALIFIED** by pressing

Press [OK] during 3 seconds to open the menu.

10-5a Switch differential setting

Go to the screen **DIFF. REGULATION** by pressing

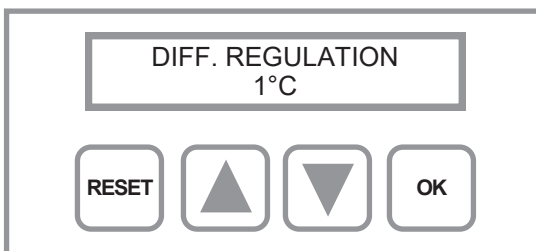

Page DIFF. REGULATION

This setting adjusts the differential for the following switches :
- Low speed / High speed
- Low speed / Stop

Factory setting : 1°C

Press [OK] during 3 seconds to modify the value.

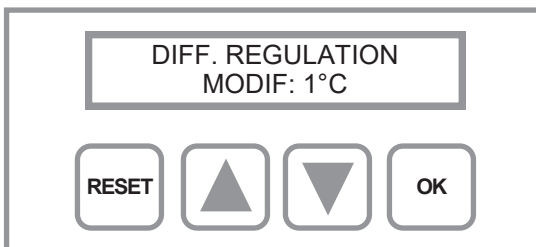

Select the temperature by pressing

(Temperature can be set up from 1°C to 3°C)

When the selected temperature is displayed, validate by pressing the button [OK]

10-5b Ventilation differential setting

Go to the screen **DIFF. BLOWING** by pressing

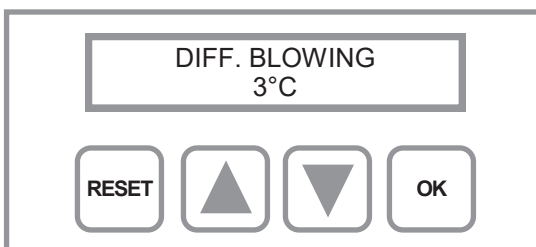

Page DIFF. BLOWING

This setting adjusts the differential to start and stop the heating ventilation.

Factory setting : 3°C

Press [OK] during 3 seconds to modify the value.

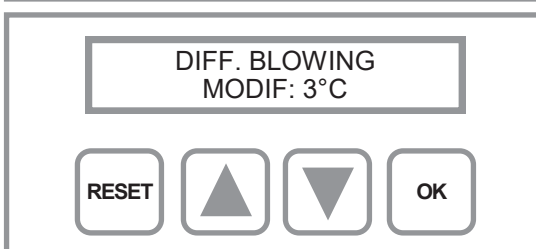

Select the temperature by pressing

(Temperature can be set up from 1°C to 3°C)

When the selected temperature is displayed, validate by pressing the button [OK]

10-5c Ventilation temporization setting

Go to the screen **DIFF. VENTIL** by pressing 

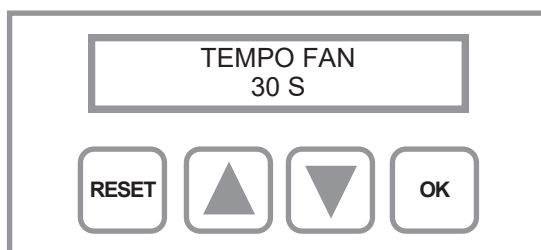

Page **TEMPO FAN**

This setting adjusts the temporization to start the blowing fans.

Factory setting: 30 S

Press [OK] during 3 seconds to modify the value.

Select the temporization by pressing ; 

(Temporization can be set up from 1S to 120S)

When the selected temperature is displayed, validate by pressing the button [OK]

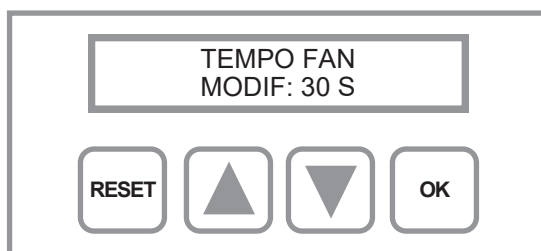

10-5d Temporization settings of switching from low speed to high speed

Go to the screen **TIMER HS ON** by pressing 

Page **TIMER HS ON**

This setting adjusts the temporization of switching from low speed to high speed.

Factory setting: 10 min

Press [OK] during 3 seconds to modify the value.

Select the temporization by pressing ; 

(Temporization can be set up from 5min to 15min)

When the selected temperature is displayed, validate by pressing the button [OK]

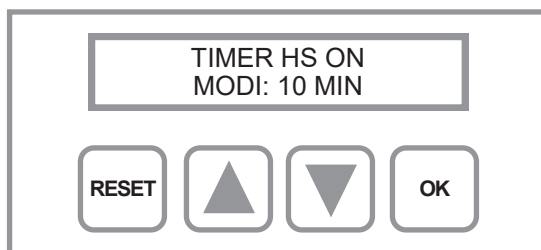
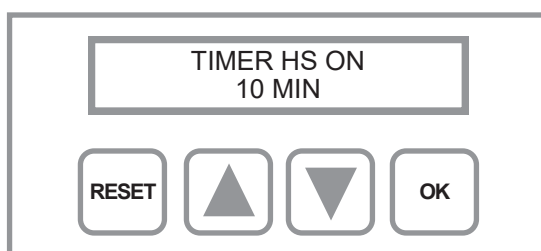

10-5e Temporization settings of burner off after high speed

Go to the screen **TIMER HS OFF** by pressing 

Page **TIMER HS OFF**

This setting adjusts the temporization beyond which the device restarts in low speed even if regulation asks for high speed.

Factory setting: 5 min

Press [OK] during 3 seconds to modify the value.

Select the temporization by pressing ; 

(Temporization can be set up from 5min to 10min)

When the selected temperature is displayed, validate by pressing the button [OK]

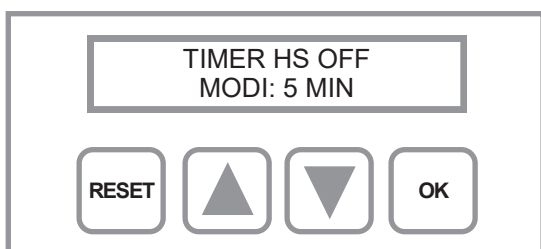
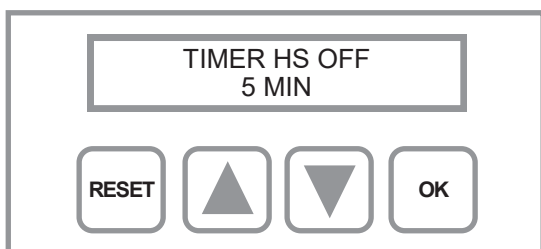

10-5f Communication speed setting

Go to the screen **MODBUS** by pressing 

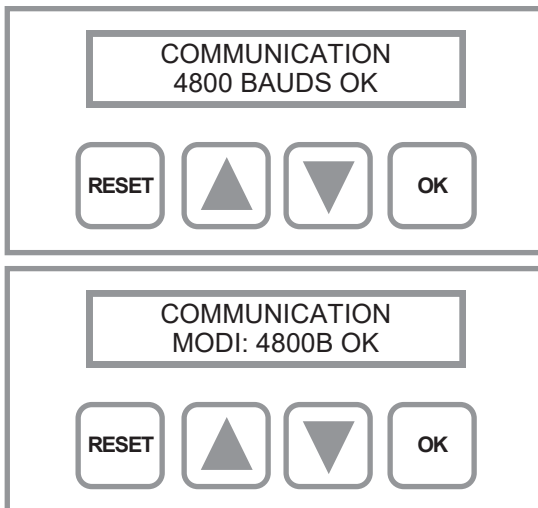

Page **MODBUS**

This setting adjusts the communication speed of the MODBUS, communication between the devices and the controller.

Factory setting : 4800 BAUDS

Press [OK] during 3 seconds to modify the value.

Select the speed by pressing
(Speed 1200, 2400, 4800)

When the selected temperature is displayed, validate by pressing the button [OK]

10-5g Information, non configurable

Go to the screen **SYSTEM** by pressing 

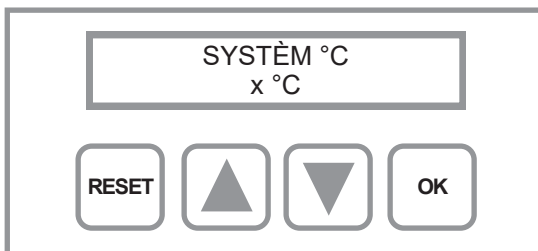

Page **SYSTEM**

This screen displays the temperature of the electronic PCB read at the instant

Go to the **PRESSURE AIR** by pressing 

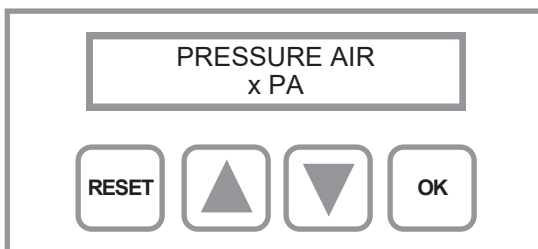

Page **PRESSURE AIR**

This screen displays the air pressure of the exhaust fan read at the instant.

Go to the **WORKING TIME** by pressing

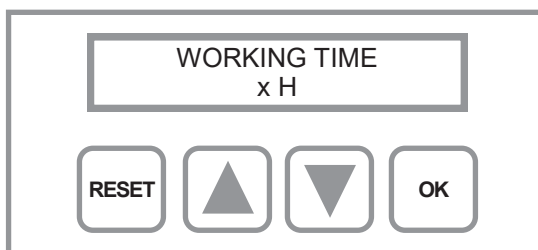

Page **WORKING TIME**

This screen displays the working time of the device in hour.

Appuyez sur la touche 

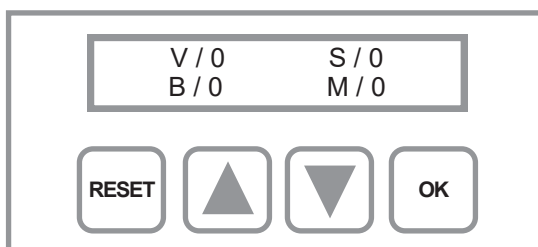

This screen displays information on device defects.

11- RECOMMENDATIONS FOR USER

Precaution to be respected :

- Never obstruct the smoke exhaust system and the fresh air intake.
- Never make any modifications to the adjustments which have been carried out by the qualified professional person.
- Never spray any water into the gas heater
- Warn the after-sales technician when there is a change of gas, gas pressure or a modification of the power supply voltage.

You are strongly recommended to take out a maintenance contract: “see with your installer”.

What should be done in case of problems?

PROBLEMS	REMEDIES
<i>Smell of gas</i>	<i>- Close the external gas valve and the electricity supply then warn the maintenance technician.</i>
<i>The burner stays in safety position (burner defect led is lighted)</i>	<i>- Press the reset button of the burner located on thermostat control box. - If the problem persists, contact the after sales technician.</i>

4heat°

Ječná 1321/29a, 621 00, Brno
info@4heat.cz
+420 513 035 275

SERVIS:
servis@4heat.cz
+420 739 456 902

